

TAKEX TRIPLE MIRROR PASSIVE SENSOR

PIR-T15WE(W)/(G)

(Wide angle protection)

Instruction Manual

Thank you for purchasing this product.

Before using the product, please read this instruction manual to ensure correct operation.

1 PRODUCT DESCRIPTION

PIR-T15WE(W)/(G) is passive infrared sensor that detects far-infrared rays emitted from the human body and output's a contact signal. Since this unit significantly reduces lost and false detection using the unique triple mirror and signal processing systems, it can be used both for indoor and outdoor applications. This unit has the following features responding to multiple applications.

- Up to 15m detection distance
- Detection distance and direction adjustable
- A mounting height of 2 to 3.5m for normal operation (max. 6m in specialized operation modes)
- Responds to operation where pets (dogs/cats) are kept, as well as at high positions, such as in gymnasiums or spaces with open ceilings
- Equipped with N.C. contact output for security and N.O. contact output for activation of the other devices
- Can be mounted on wall surfaces, as well as on poles, ceilings, and under eaves using the optional accessories (sold separately)

2 PARTS DESCRIPTION

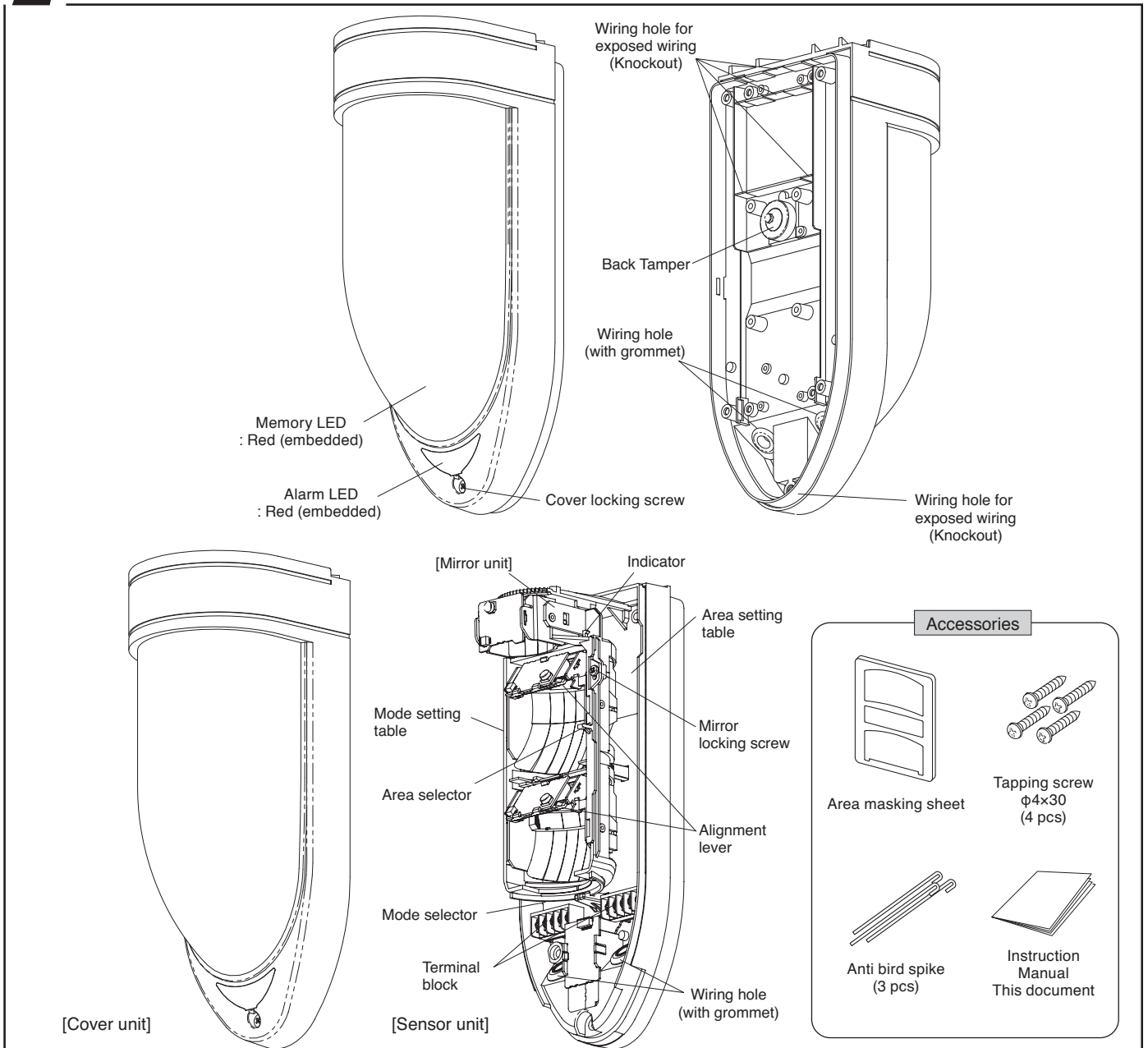

3 PRECAUTIONS

Be sure to observe

This manual describes precautions by classifying them based on degrees of danger and damage that would be generated if using the unit incorrectly.

Warning This indicates the possibility of severe injury, and even death, if ignored or a user handles the unit incorrectly.

Caution This indicates the possibility of minor injury and/or damage to properties, or of a notification delay in your system due to false operations and/or non-detection, if ignored or a user handles the unit incorrectly.

We categorize these precautions throughout the manual using the following symbols.

A prohibited action you must not do.

An action you must do, and information you should keep in mind

Warning

- Do not disassemble or modify the unit. Failure to follow this may result in fire, electric shock, and/or malfunction.
- If the following errors/malfunctions occur, power off the unit immediately, and contact your dealer. Failure to follow this may result in fire, electric shock, and/or malfunction.
 - Smoke, abnormal odor, and/or sound are found
 - Liquid, such as water, and/or foreign material has entered the unit
 - The unit is deformed and/or parts are damaged
- Do not install the unit in a place and/or with a mounting method that cannot support its weight. Failure to follow this may result in injury and/or property damage when the unit falls.

- Mount the unit on a solid ceiling or wall surfaces where reinforcement materials are used. If you mount the unit on non-wood plaster board or concrete, securely mount it using anchors and mounting screws that match the wall materials. Failure to follow this may result in injury and/or property damage if the unit falls.
- Do not use the unit with power voltage levels other than those specified. Failure to follow this may result in fire, electric shock, and/or malfunction.
- Do not connect devices that exceed the indicated capacity to the output contact of the unit. Failure to follow this may result in electric shock, fire, and/or malfunction.
- Do not touch terminals with wet hands. Failure to follow this may result in electric shock.

Caution

- Do not apply impact to the unit. Applying strong impact to the unit may result in performance deterioration and/or damage to the unit.
- The unit may not operate properly near devices that generate a strong electric or magnetic field. Also, devices near the unit may not operate properly due to the magnetic field and/or magnetism generated from the unit. Make sure to check it before operation.
- Make sure to perform sufficient operation checks on the whole system before operation.
- Securely conduct installation work according to the instruction manual. Also, make sure to use the supplied accessories and specified components. Failure to follow this may result in injury and/or property damage in the event of fire or electric shock or if the unit falls.
- Contact qualified personnel for any electrical work necessary for installation, if required. Failure to follow this may result in fire and/or electric shock.
- Do not install the unit in places subject to oil smoke or steam, high humidity, and/or a lot of dust. Electricity transmitted through oil, water, and/or dust may result in fire, electric shock, and/or false operation.
- Do not perform aerial wiring of power and signal cables. Failure to follow this may result in electric shock, fire, and/or malfunction.
- Passive infrared sensors are designed to detect changes of far-infrared ray energy. Energy changes largely when the human body moves across the detection area. However, energy does not change greatly when the human body comes closer in a straight line, or stops. In addition, if the detection area environment generates similar changes due to certain factors, the unit will issue an alarm without being able to judge properly.

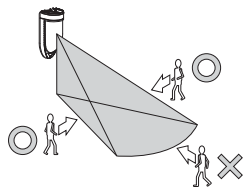

Set the area within the rated detection distance range according to the instruction manual. If you use the unit outside the specified range, an appropriate area will not have been configured, and the unit may operate unsteadily, and/or detection may fail.

- Avoid installing the unit in the following places. Otherwise, false detection may occur.
 - Places subject to strong direct or reflected light (sunlight, spotlight)
 - Places subject to rapid temperature fluctuations (air outlets of air-conditioning equipment, etc.)
 - Places where moving objects are included in the detection area (trees, branches and leaves, laundry, etc.)
 - Places subject to strong vibration and/or electric noise
 - Places where dogs, cats, birds, and/or automatic cleaning robots may pass (excluding in the pet mode operation)
 - Places where shielding objects (including glass and transparent resin, etc.) are included in the detection area (shading parts will not be detected)
 - Places where the sensor part looks inclined from the front view (the area cannot be properly configured)
 - Places that intruders can easily touch

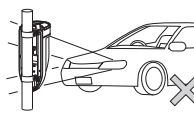

Strong light that hits the sensor

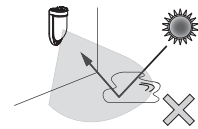

Sunlight reflection



Air outlets of air-conditioning equipment



Trees, branches and leaves, laundry

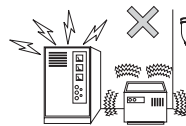

Strong vibration and/or electric noise

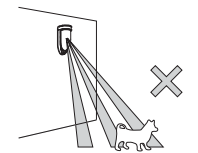

Pets, such as dogs, cats, and birds (*excluding the pet mode)

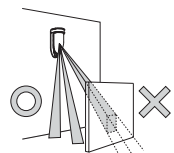

Shielding objects

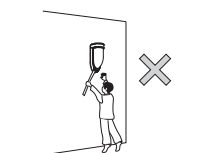

Places that people can easily touch

⚠ Caution

! Mount the unit straight so that it does not look inclined from the front and side view.

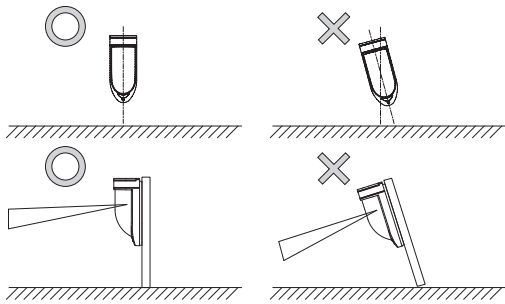

! Note that the detection distance depends on the following factors.

- Sensor installation height
(The higher within the rated range, the longer the detection distance)
- Sensor mounting status and surface gradient in the area

• When the surface in the area is downward-sloping from the sensor side
→The detection distance becomes longer

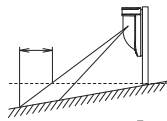

• When the surface in the area is upward-sloping from the sensor side
→The detection distance becomes shorter

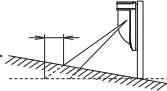

! Install the unit where the detection area faces toward a place intruders may pass through.

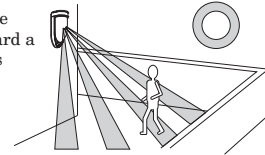

! Adjust the detection area so that it does not go beyond the site.
(Unexpected objects may be detected)

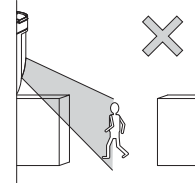

! After installation, make sure to adjust the detection area and perform sufficient operation check.

! Refer to the detection area chart, and select the installation location. Then, check the actual operation, and adjust the appropriate area.

! This unit has a rainproof structure. Not a waterproof structure. Do not hose it directly. Do not use the unit in places subject to water and/or constant high humidity, such as bathroom. Failure to follow this could result in malfunction.

! In order to maintain the rainproof structure of this unit, install it in the correct direction. Installing it sideways or upside down may result in malfunction.

! Apply caulking to wiring holes based on the installation wall material, if necessary, in order to maintain rainproof performance.

! This unit is for wall installation. When installing it on poles, ceilings, or under eaves, use the specified attachments (sold separately).

4 DETECTION AREA

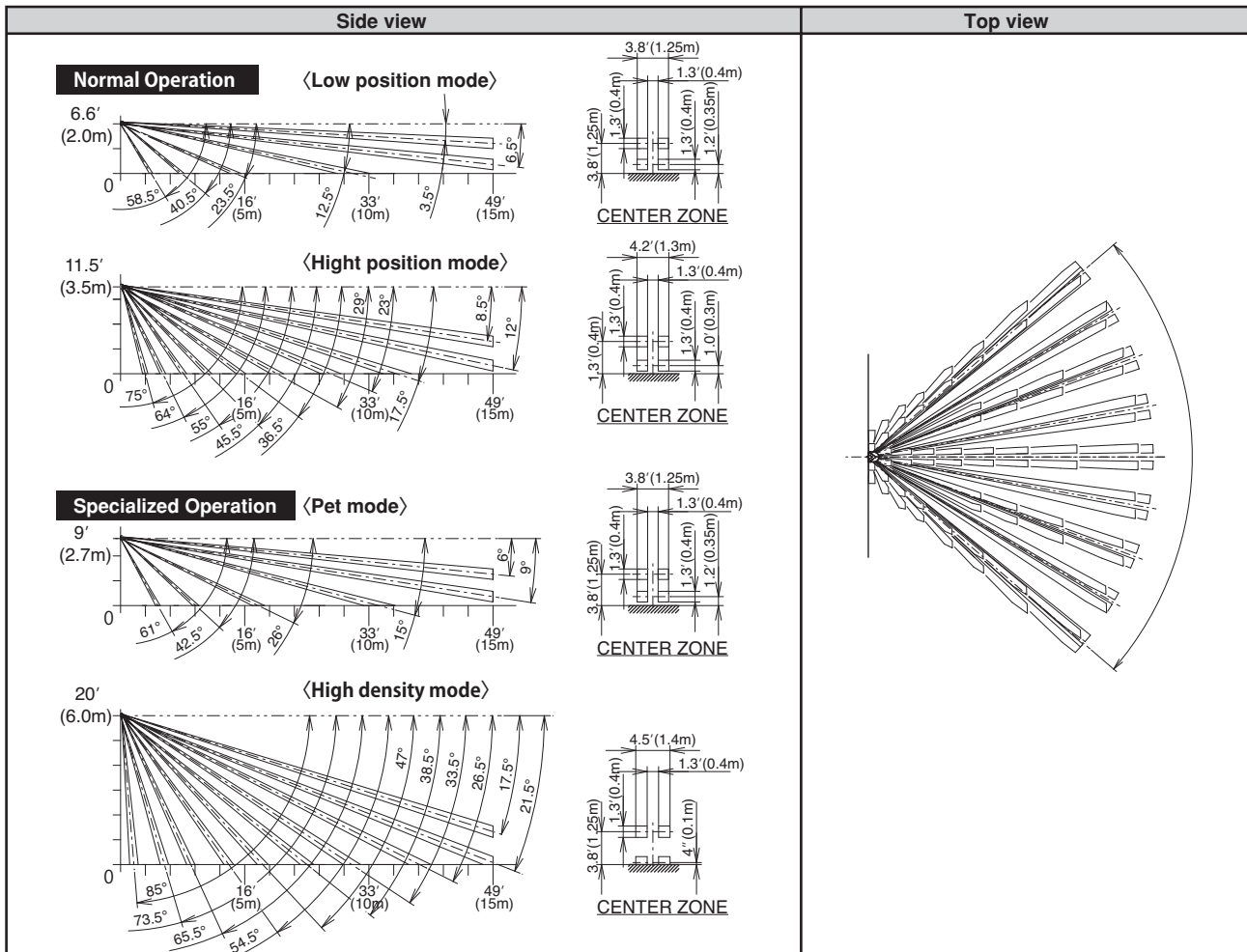

Masking method of the detection area

When there are false operation factors within the specified detection area, or you want to adjust the detection distance in the pet mode, mask the detection area with supplied area masking sheet.

* Always set the detection distance to 49' (15m) in the pet operation mode. When adjusting the detection distance, mask the detection area with supplied area masking sheet, instead of adjusting with the area selector.

When masking each detection area from ① to ③, attach the area masking sheet to the surface of the mirror unit corresponding to the detection area. Fit one end of the sheet to the arrow position and fix into place.

* Be careful not to leave dirt or oil, such as with fingerprints, on the mirror surface, when attaching the sheet.

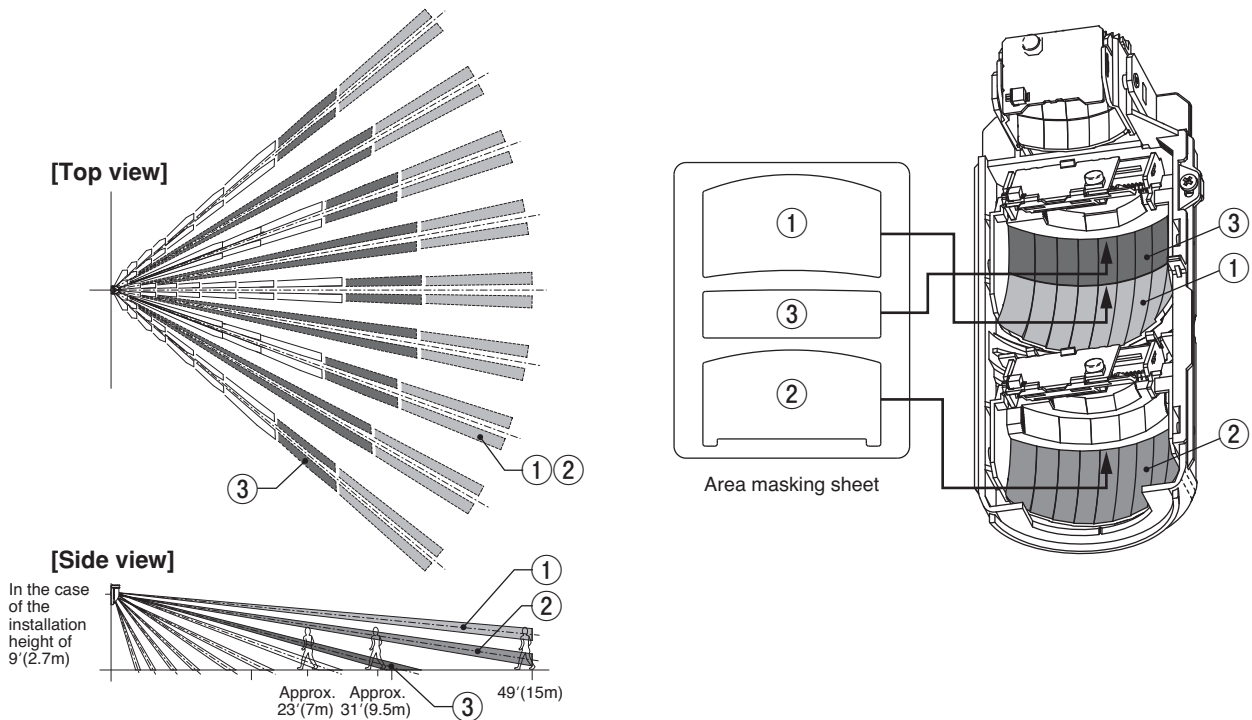

Precautions on the detection area setting

● Detection area range

Since the detection zone extends until it hits the ground or wall surface, the unit may detect objects even in places beyond the specified distance. In order to avoid unexpected detection, adjust the area sufficiently.

● Detection area distance adjustment

To set the detection distance less than the minimum of the area setting table, attach the masking sheet on the surface of the mirror unit.

(Refer to "8 ADJUSTMENT OF DETECTION AREA")

* Attach the area masking sheet in order from the longest part of the detection area, and adjust the detection distance.

● Near area cancellation setting

When the near area setting (5 of mode selector 2) is cancelled, the detection area is configured as in the figure on the right. With this setting, detection does not occur in near zones of the detection area, but only in far zones.

In the setting of installation height: 9' (2.7m) and detection distance: 49' (15m)
Near area setting cancelled
(5 of mode selector 2)

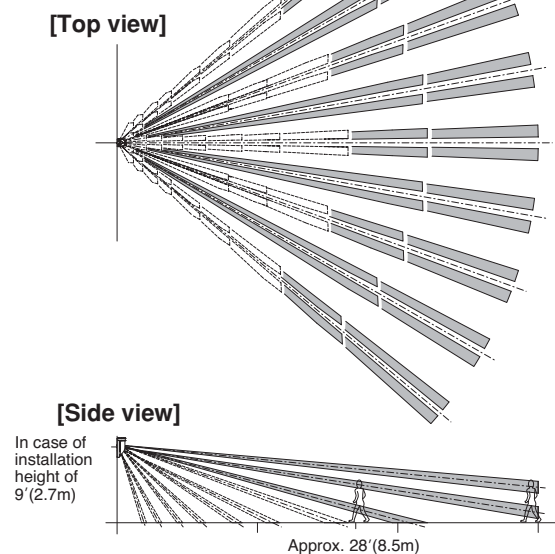

5 INSTALLATION



The installation height and adjustable detection distance depend on the operation mode. Carefully check the operation mode and detection area setting before installation and area setting.

Use the unit with the correct operation mode setting. Select operation mode to use and perform the setting correctly. This unit can be operated from ① to ④ modes, as follows.

● Normal operation modes

There are low and high position modes according to the installation height.

① Low position mode

This can be used to reduce false detection caused by small animals. Set this mode when the unit is mounted at a installation height of 6.6' to 9'(2.0 to 2.7m.)

② High position mode

This can be used to reduce false detection caused by small animals. Set this mode when the unit is installed at a mounting height of 9' to 11.5'(2.7 to 3.5m.)

* When the mounting height is 9'(2.7m), either low or high position mode can be set.

● Specialized operation modes

This is another operation mode besides normal one. There are pet mode and high density mode.

③ Pet mode

Set this mode in order to reduce false detection caused by pets (dogs, cats) and small animals. Install the unit at a installation height of 8.3' to 10'(2.5 to 3.0m.)

④ High density mode

Set this mode in order to significantly reduce non-detection of the human body in the detection area. The unit can be installed at a mounting height of 6.6' to 20'(2.0 to 6.0m.)

Choose among the above four operation modes, and set with the mode selector. (Refer to "7 FUNCTION")

	Normal Operation		Specialized Operation	
	Low Position Mode	High Position Mode	Pet Mode	High Density Mode
Mounting Height	6.6-9ft(2.0-2.7m)	9-11.5ft(2.7-3.5m)	8.3-10ft(2.5-3.0m)	6.6-20ft(2.0-6.0m)
Small Animal Tolerance	●	●	●	
Pet Immune			●	
Creep Zone Detection	● (Selectable)	● (Selectable)		●
Near Area Cancellation	● (Selectable)	● (Selectable)		

■ Mounting method

1. Loosen the cover locking screw and remove the cover unit.

2. Put the wire through the grommet in the wiring hole at the bottom of the sensor unit. Break the mounting hole knockout of the sensor unit and mount it using the supplied tapping screws.

* Installation height of the sensor should be within 8.3' to 10'(2.5 to 3.0m) in the pet mode.

* Adjust the sensor installation height using the center of the sensor housing as a guide.



Put the wires for power input and alarm output through the wiring hole on the left, and for tamper output and starting output on the right. Be careful not to cross the wires.

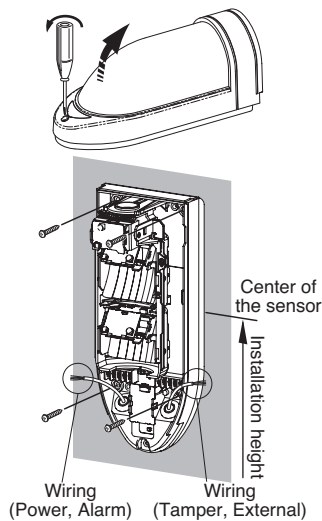

* For open wiring, break the knockout on the rear side of the sensor unit, and pull the wire through it.

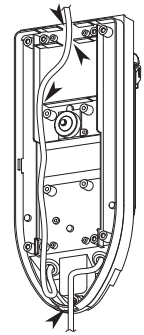

3. Connect the wires to each terminal. (Refer to "6 WIRING")

4. Set the detection area and functions according to the installation site. (Refer to "4 DETECTION AREA", and "7 FUNCTION" AREA", "8 ADJUSTMENT OF DETECTION")

5. Replace the cover unit, and fix it by tightening the cover locking screws.

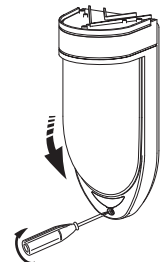

*When installing outdoors, mount the anti bird spike above the cover unit. Turn the anti bird spike and tighten it.

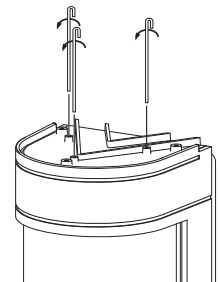

6. When the detection area and functions settings are completed, go to section "9 OPERATION CHECK".

When mounting on the pole [Use the pole attachment]

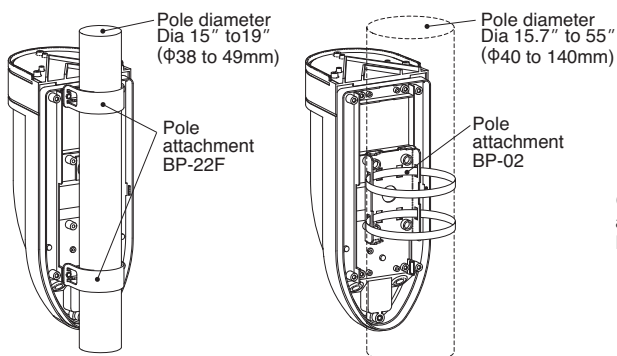

When mounting the unit on a vertical pole, use the pole attachment (sold separately). The unit can be mounted on poles of Dia 15" to 19" (φ38 to φ49mm) and Dia 15.7" to 55" (φ40 to φ140mm).

* Mount the sensor so that its mounting surface is placed vertically.

When mounting on the ceiling or under eaves [Use the ceiling attachment]

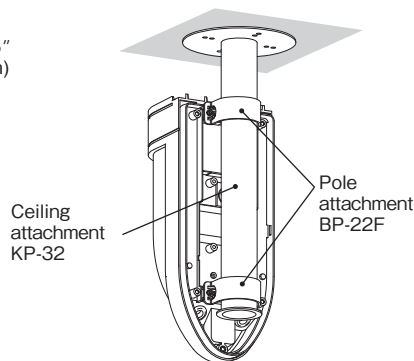

When mounting on the ceiling or under eaves, use the ceiling attachment (sold separately).

* Mount the sensor so that its mounting surface is placed vertically.

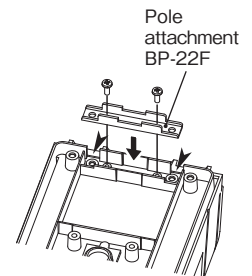

When using the pole attachment BP-22F (sold separately), break the knockout on the rear side of the sensor unit, and attach it.

6 WIRING

Terminal configuration

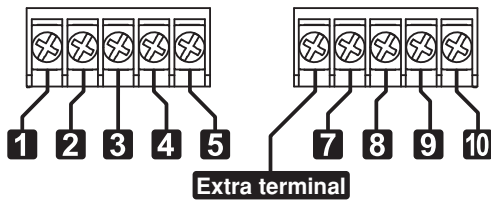

- 1 2** Power input (non-polarity)
9 to 28V DC/Max. 40mA
- 3 4** Alarm output
Contact method : Dry semi-conductor contact, N.O./N.C. selectable
Contact operation : One-shot operation (2 sec.) when detecting intrusion
Continuous output in the event of cover monitor error (until detection operation after the cover is closed)
Continuous output in the event of self diagnosis error (until normal recovery)
Continuous output in the event of power voltage error (until normal recovery)
Continuous output in the event of long-term diagnosis error (until the cover is open)
Continuous output in the event of area checker position error (until normal recovery)
Contact rating : 24V (AC/DC) 0.25A (resistive load)
(built-in contact protective resistor 3.3Ω)
- 5** LED control input (L/C)
Control lighting on/off of the alarm LED
Connect to the positive side of the power supply
- 7 8** Tamper output
Contact method : Dry mechanical contact, N.C.
Contact operation : Continuously output when the cover is open (until the cover is closed)
Contact rating : 24V (AC/DC) 0.1A (resistive load)
(built-in contact protective resistor 3.3Ω)
- 9 10** External output
Contact method : Dry semi-conductor contact N.O.
Contact operation : One-shot operation (2 sec.)/Off delay operation (2+30 sec.) selectable when detecting intrusion
* Each event output is issued as alarm output.
Contact rating : 24V (AC/DC) 0.25A (resistive load)
(built-in contact protective resistor 3.3Ω)

Standard connection

(Connection examples when using two units)

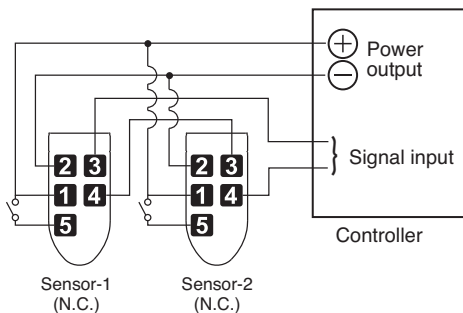

LED CONTROL FUNCTIONS

Connect terminal ⑤ through an external contact switch with power (+)

● OPERATION

Turn the Mode selector ① OFF
When the switch is turned ON, the alarm LED lights at alarm.
When the switch is turned OFF, the alarm LED does not light.

Wiring distance between sensor and power supply

	Supply Voltage 12V DC	Supply Voltage 24V DC
AWG20 (Dia 0.8mm)	2850ft (870m)	14000ft (4270m)
AWG18 (Dia 1.0mm)	4400ft (1340m)	22000ft (6700m)
AWG17 (Dia 1.1mm)	5300ft (1600m)	27000ft (8230m)
AWG16 (Dia 1.25mm)	7000ft (2130m)	33000ft (10000m)

* When 2 or more units are connected, the wiring distance is calculated by dividing above value by number of units

7 FUNCTION

Function

Area checker

This function can be used to visually check the sensitive zone in the detection area by lighting the LED equipped inside the mirror unit.

Self diagnosis

This function is used to monitor errors with detection elements or sensor circuits, and damaged/disconnected wiring. If damage or disconnection occurs, alarm will be issued using alarm output and alarm LED. Reset the power of the sensor during alarm to stop it. After warming-up operation finishes, monitoring will start again. When an alarm is issued, check the sensor operation immediately.

Low voltage monitoring

This function is used to issue an alarm when the power voltage level supplied to the sensor decreases abnormally (to approx. 8.5V or less). Alarm is issued using alarm output and alarm LED before the sensor operation becomes unstable. It works even during the warming-up operation. When the power voltage level returns to normal during an alarm, the warning automatically stops. When an alarm is issued, check the power voltage immediately.

Area checker position monitoring

This function is used to issue an alarm using alarm output and alarm LED when the area checker unit equipped inside the mirror unit has not returned to the original position.
(Refer to "8 ADJUSTMENT OF DETECTION AREA")

Cover monitoring

This function is used to monitor the status of the cover unit, open or closed, and issue an alarm against vandalism. It detects the opening and closing of the cover unit, and issue an alarm using alarm output of alarm operation and alarm LED. When the cover is normally attached, the memory indicator blinks for 10 seconds. After the lighting goes off, alarm stops when the sensor has operated detection (twice). When an alarm is issued, check the sensor operation immediately.

* When you open and close the cover for inspection, make sure to confirm detection operation twice or more, and reset an alarm.

Description of mode selector

Use the mode selectors 1 and 2 inside the sensor unit for various settings.

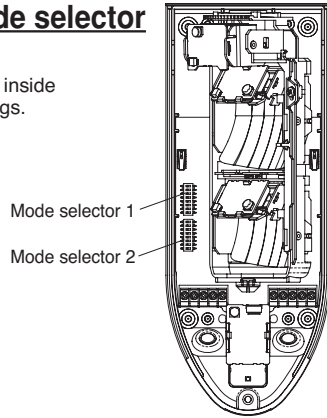

Mode selector 1

Alarm LED setting (1 of mode selector 1)

Sets the alarm LED (red) to light on/off.

ON : Enables lighting
OFF: Light is always off
Indicates abnormal output only.

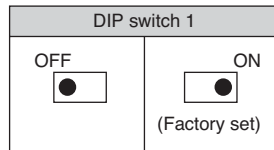

Memory function setting (2 of mode selector 1)

Sets the memory function to be enabled/disabled.

ON : Enabled
Sets the lighting operation pattern at 2 of mode selector 2.
OFF: Disabled

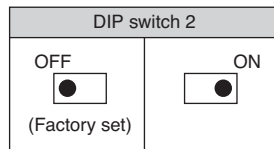

Sensitivity setting (3 of mode selector 1, 4 of mode selector 1)

Sets detection sensitivity.

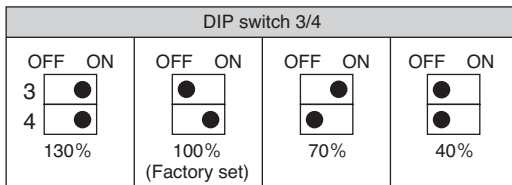

[130%] Select this option when the temperature of detection targets is low, or the temperature difference between the background and the targets becomes small, for example, in summer.

[100%] Factory default setting.

[70%] Select this option when heat sources besides detection targets are often detected with the sensitivity setting at 100%. However, if the temperature difference between detection targets and the background is small, they may not be detected. Make sure to check if detection targets can be detected.

[40%] Select this option when heat sources besides detection targets are often detected with the sensitivity setting at 70%. However, if the temperature difference between detection targets and the background is small, they may not be detected. Make sure to check if detection targets can be detected.

Tamper

This function is used to monitor the status of the cover unit, attached or removed and issue an alarm against vandalism. If the cover unit is removed, or improperly mounted, alarm will be issued by tamper output. When the cover is attached normally, alarm stops. When an alarm is issued, check the sensor operation immediately.

Temperature compensation

This function is used to automatically adjust the detection sensitivity based on the temperature around the sensor.

Environmental adjustment setting (5 of mode selector 1)

Sets when false operations frequently occur.

ON : Enabled
OFF: Disabled

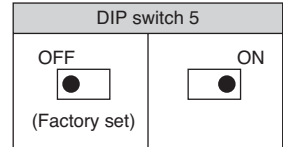

Operation mode setting (6 and 7 of mode selector 1)

Sets based on the sensor operation mode.

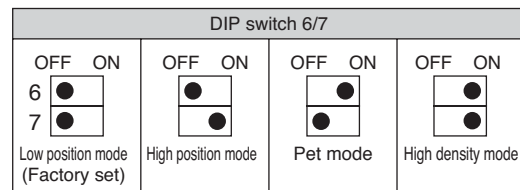

Low position mode : Select when the installation height is 6.6' to 9'(2.0 to 2.7m.)

High position mode : Select when the installation height is 9' to 11.5'(2.7 to 3.5m.)

Pet mode : Select if pets may enter the detection area.

(Install the unit at the installation height of 8.3' to 10'(2.5 to 3.0m))

High density mode : Select when the installation height is high, or you need to detect objects more accurately.

(False alarm may increase for outdoor use)

Creep zone detection setting (8 of mode selector 1)

This setting can be used to detect objects passing in the area directly alongside the walls. Note that pet immunity performance decreases when this setting is enabled. In the specialised operation (pet mode), this setting is disabled.

ON : Enabled
OFF: Disabled

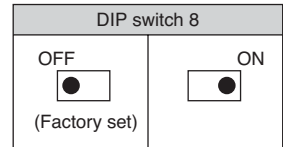

Mode selector 2

Walk test setting (1 of mode selector 2)

This setting is used to light up only for a certain period of time even if the alarm function setting (switch 1-1) is disabled. Lighting can be turned ON while the power timer (during warming-up) is on and the following 5 minutes, and for 5 minutes after the cover is closed.

ON : Enabled
OFF: Disabled

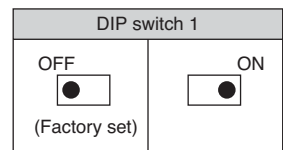

Memory LED operation setting (2 of mode selector 2)

This setting is used to set the blinking operation of the memory LED (red). This can be set only when 2 of mode selector 1 [memory LED setting] is ON.

ON :When the sensor triggers an alarm, the memory LED blinks for 3 minutes, and lights for 47 minutes, then the light goes off. (When the sensor triggers an alarm again during lighting, the timer will be triggered, and the LED will stay lit for another 47 minutes)

OFF:When the sensor triggers an alarm, the memory LED blinks for 50 minutes, and the light goes off. (When the sensor triggers an alarm again during blinking, the timer will be triggered, and the LED will continue to blink for another 50 minutes)

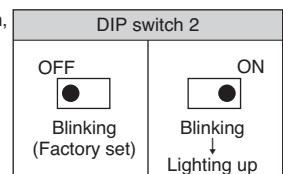

Alarm contact output changeover setting (3 of mode selector 2)

This setting can be used to apply the alarm output logic to N.O./N.C. contact.

ON : N.O.
OFF: N.C.

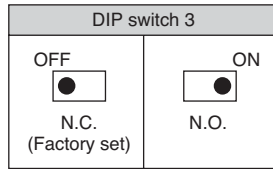

Output for external device setting (4 of mode selector 2)

This setting can be used to set the output time of external output.

ON :Off-delay (2+30 sec.)
(When the sensor triggers an alarm again during off-delay time, the timer will be reset, and the unit will continue to output for another 30 seconds)
OFF:One-shot (2 sec.)

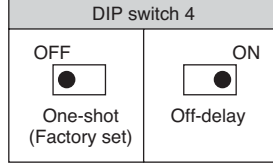

Near area cancellation setting (5 of mode selector 2)

When there are false operation factors in the area near the sensor, this setting can be used to set either detection or non-detection. When the creep zone detection setting or the pet/high density operation mode is ON, this setting is disabled.

ON : Near area invalid
OFF: Near area valid

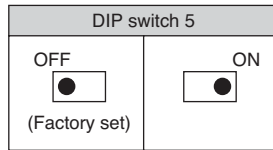

Long-term diagnosis setting (6 of mode selector 2)

This setting is used to set off an alarm after there has been no alarm operation for a long period of time (approx. 1 week). Alarm goes off and alarm LED lights up. Open/close the cover to reset the alarm.

ON : Enabled
OFF: Disabled

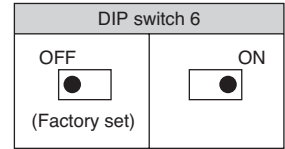

Factory set

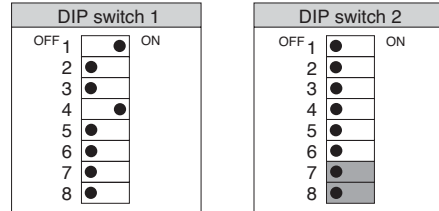

* Keep the setting OFF in 7 and 8 of mode selector 2 for operation.

Description of LED operation

Alarm LED operation

- Lights up (for approx. 2 sec.) → When detecting intrusion (lights up for approx. 2 seconds simultaneously with alarm output)
- Continuously lit → Area checker position error (ends when the area checker position is reset)
Power voltage error (lights up after a power voltage error is detected, and ends when power voltage returns to normal, or the power is reset)

- Blinks (for approx. 1 min.)... → During warming-up (blinks for approx. 1 minute after the power is turned ON)

- Continuously blinks (1) ... → Cover monitor error (starts blinking after opening the cover and closing it, and ends when the sensor operates detection twice after a lapse of 10 seconds)
Long-term diagnosis error (starts blinking when a long-term diagnosis error is detected, and ends after closing the cover and opening it)

- Continuously blinks (2) ... → Self diagnosis error (starts blinking when a self diagnosis error is detected, and ends when the unit is normally recovered, or the power is reset)

Memory LED operation

- Blinks for 3 minutes, and then is lit for 47 minutes ... → When memory is indicated [auto reset operation: light goes off after blinking for 3 minutes, and then is lit for 47 minutes] (retrigger enabled during lighting)

- Blinks for 50 minutes ... → When memory is indicated [auto reset operation: light goes off after blinking for 50 minutes](retrigger enabled during lighting)

- Continuously blinks ... → Cover monitor error (blinking for 10 seconds after opening the cover and closing it)

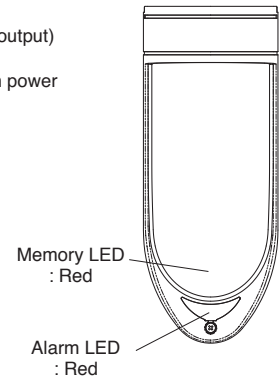

8 ADJUSTMENT OF DETECTION AREA

Detection area adjustment method

The detection area and detection operation can be optimally set, as follows:

- Operating the area selector enables to adjust the distance of the detection area.
- Turning the mirror unit enables the user to adjust the detection area in a horizontal direction.

AREA SELECTOR

		DETECTION DISTANCE				
		25ft (7.5m)	30ft (9m)	33ft (10m)	40ft (12m)	49ft (15m)
INSTALLATION HEIGHT	6.6ft (2m)	B/C	B	A/B	A/B	A
	8.3ft (2.5m)	C	B/C	B/C	B	A/B
	9ft (2.7m)	C/D	C	B/C	B	A/B
	10ft (3m)	D	C/D	C	B/C	B
	11.5ft (3.5m)	E	D	C/D	C	B/C
	16ft (5m)	—	—	F	E	D
20ft (6m)	—	—	—	F	E	

- [Example 1] Installation height: 6.6'(2m)
To set the maximum distance to 49'(15m):
Choose area selector [A]
- [Example 2] Installation height: 10'(3m)
To set the maximum distance to 30'(9m):
Choose area selector [C/D]
- [Example 3] Installation height: 16'(5m)
To set the maximum distance to 33'(10m):
Choose area selector [F]

* Do not set the detection distance to less than 25'(7.5m) in the area selector. To set a distance of less than 25'(7.5m), attach the masking sheet and adjust the area. (Refer to "4 DETECTION AREA")

* Always set the detection distance to 15m in pet mode. When adjusting the detection distance, use the supplied area masking sheet and mask the detection area instead of adjusting with the area selector. (Refer to "4 DETECTION AREA")

Detection distance adjustment

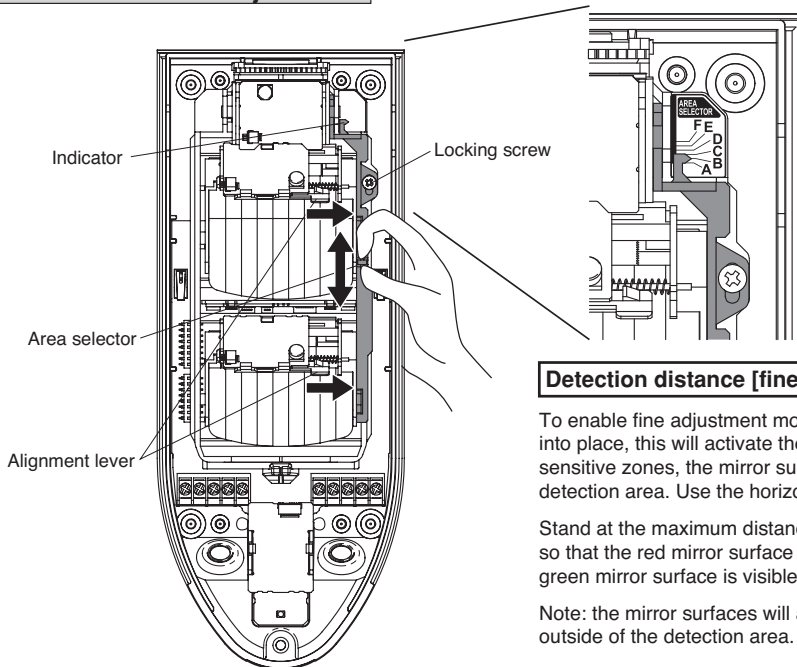

Detection distance [rough adjustment]

Refer to the area setting table inside the sensor unit, and set the detection area corresponding to the installation site using the area selector and indicator. Then tighten the locking screw. (When moving the area selector up and down, the indicator will show the letters from A to F. Select the position based on the installation height and maximum detection distance.)

- [Example] Installation height: 10'(3m)
To set the maximum distance to 49'(15m):
Choose area selector [B]

Detection distance [fine adjustment] using LED area checker

To enable fine adjustment mode slide the two alignment levers to the right and latch into place, this will activate the alignment LEDs. Look at the sensor to check the sensitive zones, the mirror surfaces will appear red or green when standing inside the detection area. Use the horizontal direction adjustment to fine-tune as required.

Stand at the maximum distance of your desired coverage and adjust the area selector so that the red mirror surface is visible between shoulder and chest height, and the green mirror surface is visible between waist and knee height.

Note: the mirror surfaces will appear unlit when standing outside of the detection area.

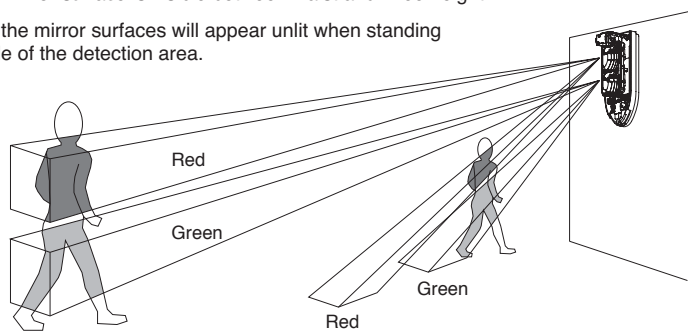
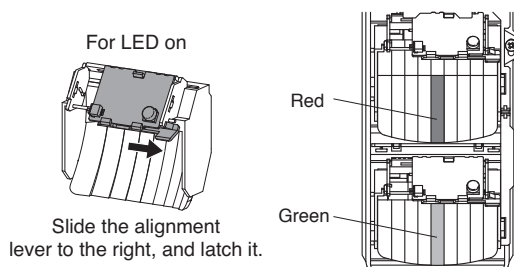

! When the zone faces toward a place where false operation can occur (refer to "3 PRECAUTIONS), adjust or mask the area to avoid.

Horizontal direction adjustment

Turn the mirror unit to the direction you want to protect to adjust the detection area.
(±45° adjustable [in 5° steps])

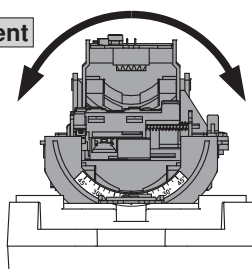

When the adjustment has been completed unlatch both alignment levers and ensure they return to the left edge of each mirror unit. If the levers are not returned to the original position the unit will issue a continuous alarm output and the alarm LED will illuminate.

For LED off

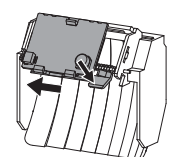

Unlatch the alignment lever and return to its original position

9 OPERATION CHECK

1. When the power is turned ON, the alarm LED (red) starts blinking, which shows warm up status. Wait approximately 1 minute until blinking ends. (No blinking operation when the alarm LED is set to OFF) The unit does not issue alarm during warm up.
2. After the LED stops blinking, walk across the detection area. Check that the alarm LED lights up. Close the cover and walk across the detection area, and check operation on both the sensor (LED) and connected device (controller).

* When the alarm LED is set to OFF for operation, use the walk test function and check operation.

10 TROUBLESHOOTING

If the unit does not operate properly, refer to the following table and check the unit.
If the unit cannot be restored to normal operation after checking, contact the dealer or TAKEX.

Status	Cause	Remedy
Unit does not operate at all	<ol style="list-style-type: none"> (1) Power is not turned ON (including cable disconnection), or the power voltage is too low. (2) Approximately 1 minute has not passed since the power is turned ON (The alarm LED is blinking) (3) There are shielding objects in front of the detection area (Note that glass is considered as a shielding object) (4) Detection area setting is inappropriate 	<ol style="list-style-type: none"> (1) Check the power wire and set the power voltage properly (2) Wait approximately 1 minute (3) Remove shielding objects (4) Set the detection area again
Unit does not operate from time to time	<ol style="list-style-type: none"> (1) Detection area setting is inappropriate (2) Cover surface is dirty with dust or water (3) Detection distance is inappropriate (4) Temperature difference between the human body and surrounding area is small 	<ol style="list-style-type: none"> (1) Set the detection area again (2) Wipe off dirt using a soft, dry cloth (Do not use any chemicals, such as thinner or benzene, which may result in damage to the unit) (3) Set the detection distance within the rated distance (Maximum detection distance: 49' (15m), mounting height: between 6.6' to 20' (2.0 to 6.0m)) (4) Set the sensitivity setting to 130%
Unit operates when no human body passes through the area	<ol style="list-style-type: none"> (1) Power voltage is unstable (2) There are moving objects (such as pets), or equipment subject to rapid temperature fluctuations (such as air outlets or outdoor units of air-conditioning equipment, refrigerator, or clothes dryer) (3) There are sources to generate electric noise (4) Unit is subject to strong sunlight reflection or headlights (5) Unit detects human bodies passing outside the detection area (6) Sensitivity setting is high (7) Unit detects pets (8) Unit detects an automatic cleaning robot 	<ol style="list-style-type: none"> (1) Set the power voltage properly (2) Remove objects causing the trouble (3) Change the mounting place (4) Change the mounting place, or shield the light using shades (5) Set the detection area again (6) Set the sensitivity setting to 70% or 40% (7) Keep pets away from the detection area Set to the pet operation mode (installation height: between 8.3' to 10' (2.5 to 3.0m)) (8) Keep automatic cleaning robots away from the detection area
Alarm LED lights up, but the connected device does not operate	<ol style="list-style-type: none"> (1) Alarm signal is not transmitted properly, or wiring is disconnected or short-circuited (2) Alarm contact output is not issued (3) Alarm output setting is inappropriate (4) Connected devices do not operate properly 	<ol style="list-style-type: none"> (1) Fix poor wiring, disconnection, and short-circuit (2) Use a tester and check the output terminals (3) Change the alarm output setting (4) Check connected devices
Alarm LED continues to light or blink, and the alarm goes on continuously (Abnormal detection)	<ol style="list-style-type: none"> (1) Check if the abnormal detection status is generated after warming up even if the power is reset 	<ol style="list-style-type: none"> (1) Disconnection or damage may occur inside the unit

Daily inspection

1. For maintenance, wipe the unit clean using a soft, wet cloth, and wipe off any water. If the unit is seriously dirty, lightly wipe the unit clean using a soft cloth that has been immersed in water diluted neutral detergent, and the wipe off the detergent completely. Do not use thinners or benzene. (Otherwise plastic components may become deformed, discolored, or changed)
2. Check operation periodically, approximately every week. Also make sure to check operation when you move tables and partitions and change the layout in protected rooms.

11 SPECIFICATIONS

Model	Triple mirror passive sensor	
Model number	PIR-T15WE(W)	PIR-T15WE(G)
Detection system	Passive infrared	
Detection area	Wide angle (80°) detection Detection distance: 49'(15m), 108 rays (54 pairs)	
Power supply	9 to 28V DC (non-polarity)	
Current consumption	Max. 40mA	
Alarm output	Contact method : Dry semi-conductor contact, N.C./N.O. selectable Contact operation : One-shot operation when detecting intrusion Continuous output in the event of cover monitor error Continuous output in the event of alignment position error Continuous output in the event of self diagnosis error Continuous output in the event of power voltage error Continuous output in the event of long-term diagnosis error Contact rating : 24V (AC/DC) 0.25A (resistive load) (built-in contact protective resistor 3.3Ω)	
External output	Contact method : Dry semi-conductor contact N.O. Contact operation : One-shot operation/Off delay operation selectable when detecting intrusion Contact rating : 24V (AC/DC) 0.25A (resistive load) (built-in contact protective resistor 3.3Ω)	
Tamper output	Contact method : Dry mechanical contact, N.C. Contact operation : Continuous output Contact rating : 24V (AC/DC) 0.1A (resistive load) (built-in contact protective resistor 3.3Ω)	
Alarm LED	Red LED : Blinks* during warm up Lights up* when detecting intrusion Continuously blinks in the event of cover monitor error Continuously lit in the event of alignment position error Continuously blinks in the event of self diagnosis error Continuously lit in the event of power voltage error Continuously blinks in the event of long-term diagnosis error (*ON/OFF selectable using the mode selector)	
Memory LED	Red LED : Blinks for 3 minutes during memory display, Auto reset operation either of continuous lighting for 47 minutes or blinking for 50 minutes selectable (Blinks to lights/blinks, ON/OFF selectable using the mode selector)	
Functions	Sensitivity selection Operation mode selection Alarm memory LED Self diagnosis Low voltage monitoring Temperature compensation Front & back tamper LED area checker Environmental adjustment Creep zone detection Walk test mode Near area cancellation Long-term diagnosis	
Installation height	6.6' to 20'(2.0 to 6.0m) (varies depending on the operation mode) • Low position mode : 6.6' to 9'(2.0 to 2.7m) • High position mode : 9' to 11.5'(2.7 to 3.5m) • Pet mode : 8.3' to 10'(2.5 to 3.0m) • High density mode : 6.6' to 20'(2.0 to 6.0m)	
Area angle adjustment range	Horizontal direction:±45° (in 5° steps) Vertical direction :17° (no stage adjustment)	
Ambient temperature range	-25 to +55°C (no condensation and freezing)	
Mounting position	Indoor/outdoor wall surface * Can be mounted on poles and ceilings (or under eaves) using optional accessories	
IP rating	IP55	
Connections	Terminals (M2.6 self up terminal)	
Weight	Approx. 600g	
Appearance	Body:Resin (white), Window:Resin (white)	Body:Resin (gray), Window:Resin (white)

12 EXTERNAL DIMENSIONS Unit: inch (mm)

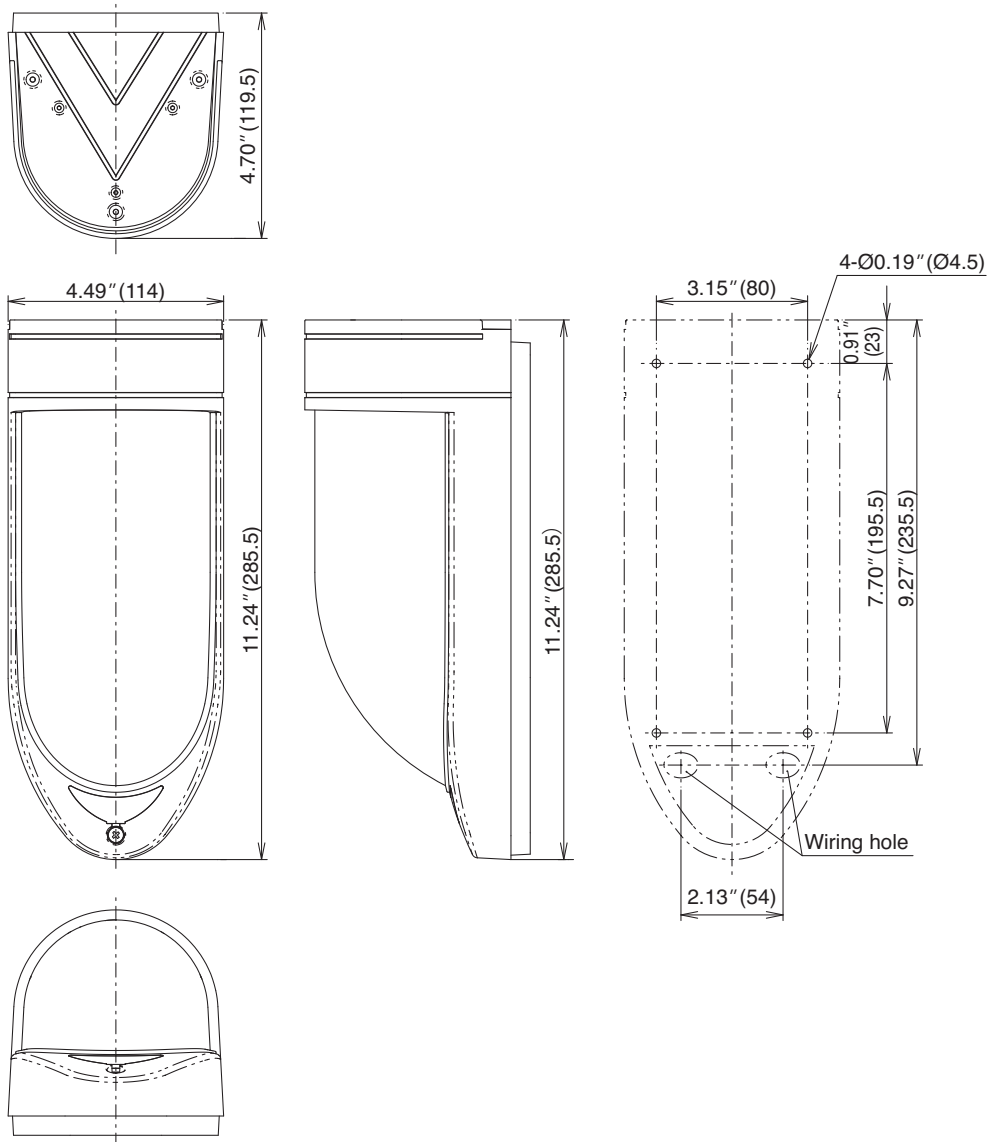

- Options : Pole attachment BP-22F
- Pole attachment BP-02
- Ceiling attachment KP-32

Limited Warranty :

TAKEX products are warranted to be free from defects in material and workmanship for 12 months from original date of shipment. Our warranty does not cover damage or failure caused by natural disasters, abuse, misuse, abnormal usage, faulty installation, improper maintenance or any repairs other than those provided by TAKEX. All implied warranties with respect to TAKEX, including implied warranties for merchantability and implied warranties for fitness, are limited in duration to 12 months from original date of shipment. During the Warranty Period, TAKEX will repair or replace, at its sole option, free of charge, any defective parts returned prepaid. Please provide the model number of the products, original date of shipment and nature of difficulty being experienced. There will be charges rendered for product repairs made after our Warranty Period has expired.



In Japan
Takenaka Engineering Co., Ltd.
 83-1, Gojo-sotokan,
 Higashino, Yamashina-ku,
 Kyoto 607-8156, Japan
 Tel : 81-75-501-6651
 Fax : 81-75-593-3816
<http://www.takex-eng.co.jp/>

In the U.S.
Takex America Inc.
 151 San Zeno Way
 Sunnyvale,
 CA 94086, U.S.A
 Tel : 408-747-0100
 Fax : 408-734-1100
<http://www.takex.com>

In Australia
Takex America Inc.
 4/15 Howleys Road, Notting Hill,
 VIC, 3168
 Tel : +61 (03) 9544-2477
 Fax : +61 (03) 9543-2342

In the U.K.
Takex Europe Ltd.
 Takex House, Aviary Court, Wade Road,
 Basingstoke, Hampshire. RG24 8PE, U.K.
 Tel : (+44) 01256-475555
 Fax : (+44) 01256-466268
<http://www.takexeurope.com>