

TAKEX DUAL ZONE OUTDOOR PIR

MX-12FAM

Instruction Manual

Thank you for your purchase of this TAKEX passive infrared sensor.

This sensor will provide a long and dependable service when properly installed. Please read this Instruction Manual carefully for correct and effective use.

Please Note : This sensor is designed to detect intrusion and to initiate an alarm; it is not a burglary-preventing device. TAKEX is not responsible for any damage, injury, or loss caused by accident, theft, Acts of God (including lightning), abuse, misuse, abnormal usage, faulty installation or improper maintenance.

PRODUCT DESCRIPTION:

The dual zone outdoor PIR is an automatic switch which uses passive infrared technology to detect infrared emitted from a human (body temperature). Suitable for indoor/outdoor use, this sensor provides detection coverage of 12 m x 180 degrees, with independent outputs for alarm and external devices per left/right (90 degree) side, adjustable individually.

1 PRECAUTIONS

- ⊘ A prohibited action, you must not do. ⚠ An action you must do, and information you should keep in mind.

Warning This indicates the possibility of severe injury, and even death, if ignored or a user handles the unit incorrectly.

- | | |
|--|--|
| <ul style="list-style-type: none"> ⊘ Do not disassemble or alter this product. ⊘ Immediately stop power supply in the event of abnormal condition. ⊘ Do not connect devices which exceed the capacitance of this sensor. ⊘ Strictly observe the specified voltage (9 to 28V DC). | <ul style="list-style-type: none"> ⚠ Mount the sensor securely in an optimal position. ⊘ Immediately stop power supply in the event of water entry. ⊘ Do not use the sensor in a location with high humidity. |
|--|--|

Caution This indicates the possibility of minor injury and/or damage to properties, or of a notification delay in your system due to false operations and/or non-detection, if ignored or a user handles the unit incorrectly.

<p>⊘ Avoid electrical noise</p>	<p>⊘ Avoid exhaust vent</p>	<p>⊘ Remove all obstructions</p>	<p>⊘ Avoid strong light</p>
<p>⊘ Avoid spraying water with a hose</p>	<p>⚠ Ensure that people cross the detection area</p>	<p>⚠ Keep installation height 0.8 to 1.2m (2.6' to 4.0')</p>	<p>⚠ Remove obstructions, including glass</p> <p style="text-align: center;">Non-detection area</p>
<p>⚠ Install perpendicularly</p>	<p>⚠ Follow these mounting condition</p> <p>Increase</p> <p>Decrease</p>	<p>⚠ Avoid detection of cars/motorcycles on the roadside. The detection zone extends to 12m ahead; there is a possibility of detecting vehicles with temperature differences.</p> <p style="text-align: center;">12m (40')</p> <p style="text-align: right;">Range in which people are detected</p> <p style="text-align: right;">Range in which cars are detected</p>	

2 PARTS DESCRIPTION

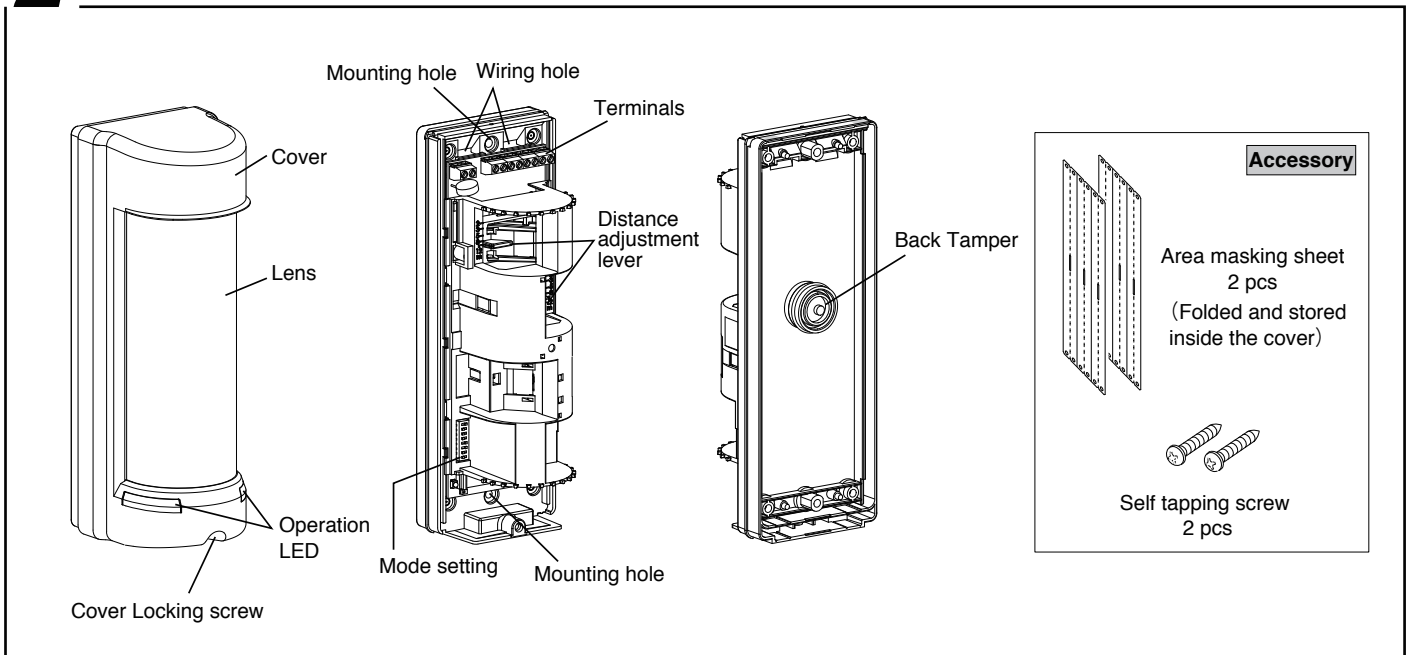

3 INSTALLATION

3-1 Before mounting

Loosen the cover locking screws and remove the cover.

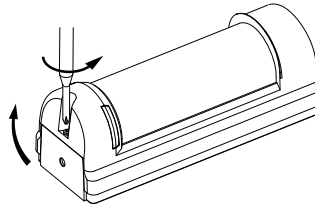

3-2 Wall mount

[Embedded wiring]

- (1) Align the back of sensor with the wiring from the wall.
- (2) Feed the wiring through the wiring hole and connect it to the terminals.
- (3) Use sealant and caulk the gap around the wiring.

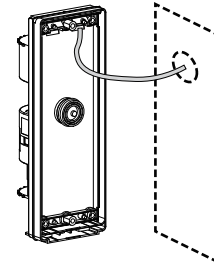

Knockout

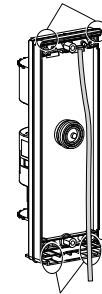

Knockout

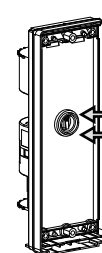

Active (Factory set)

Back Tamper

Inactive

[External wiring]

- (1) Break off the desired knockout before wiring.
- (2) Feed the wiring through the wiring hole and connect it to the terminals.
- (3) Use cable conduit and joint boxes to cover the wiring.
- (4) Use sealant to caulk the gap around the wiring.



Make sure that sealant is used to caulk the wiring hole and gaps.

- (5) Select Active or Inactive Back Tamper by reversing the rubber switch cover.

- (6) Fix the sensor using the supplied screws.

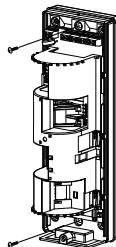

3-3 Pole mount

* Use the pole attachment BP-32 sold separately.
(for pole dia 38mm to 45mm (1.50" to 1.77"))

- (1) Break off the pole mounting knockouts.
- (2) Fit the pole mounting brackets to the sensor.
- (3) Select Active or Inactive Back Tamper by reversing the rubber switch cover.
- (4) Use sealant to caulk the screw hole and the gap around wiring entry.
- (5) Fit the pole fixing bracket around the pole and fix the sensor with screws.
- (6) Make sure that the sensor is not inclined when viewed in front or laterally.

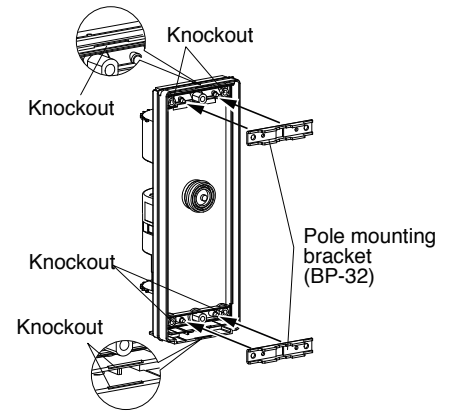

Make sure that sealant is used to caulk the wiring hole and screw hole.

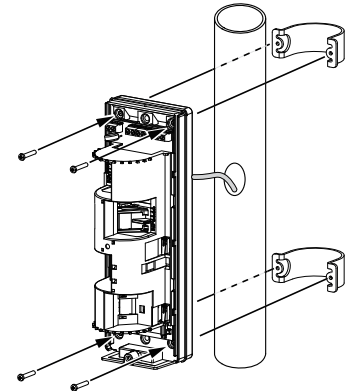
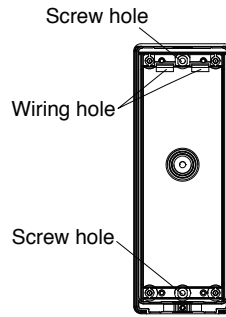

4 WIRING

4-1 Terminal Configuration

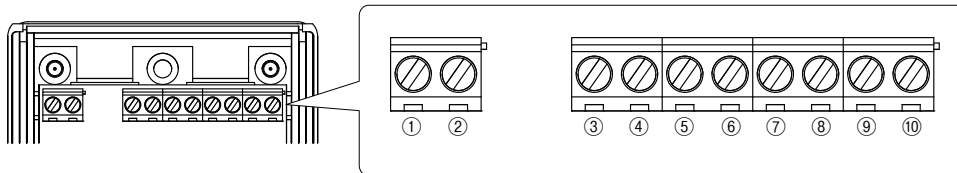

①	②	③	④	⑤	⑥	⑦	⑧	⑨	⑩
POWER		ALARM(1)		ALARM(2)		TROUBLE		TAMPER	
		ALARM RIGHT + LEFT		EXTERNAL OUTPUT					
		Mode setting "8" ON							
		ALARM RIGHT		ALARM LEFT					
		Mode setting "8" OFF							

- POWER : 9 to 28V DC (non-polarity) Current consumption 30mA Max.
- ALARM OUTPUT (1) : 30V (AC/DC) 0.2A Max. (Resistive load), N.O./N.C. selectable
- ALARM OUTPUT (2) : 30V (AC/DC) 0.2A Max. (Resistive load), N.O./N.C. selectable
(For EXTERNAL OUTPUT : N.O. only)
- TROUBLE OUTPUT : 30V (AC/DC) 0.2A Max. (Resistive load), N.C.
- TAMPER OUTPUT : 30V (AC/DC) 0.1A Max. (Resistive load), N.C.

4-2 Wiring distance

Size of wire used	Power voltage	
	DC12V	DC24V
0.3mm ² (φ 0.65mm)	450m (1400')	2400m (7800')
0.5mm ² (φ 0.8mm)	700m (2200')	3600m (11800')
1.1mm ² (φ 1.2mm)	1600m (5200')	8100m (26500')
2.0mm ² (φ 1.6mm)	2900m (9500')	14500m (47500')

Wire size: AWG24 ~ AWG14 (0.2mm² ~ 2mm²)

- NOTE: 1) Maximum wiring distance
= Value of Power voltage / Number of sets
- 2) Max signal line distance: 1,000m (3,000ft.)
(with AWG 22 (dia. 0.65mm) telephone wire)

5 SETTING

5-1 PIR Detection area

[Wide angle detection]

TOP VIEW

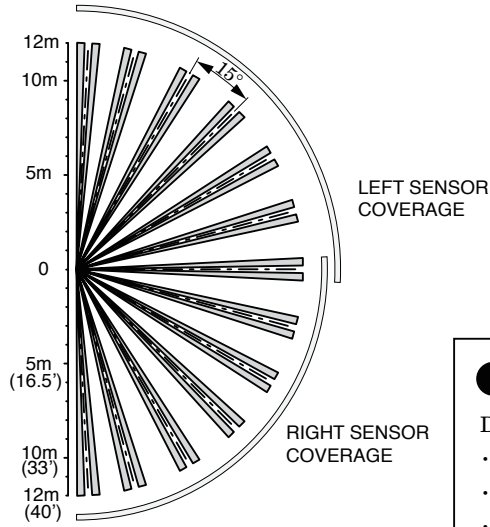

SIDE VIEW

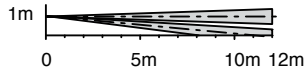

[Wall detection]

Make necessary area masking
Set the pulse count to 1

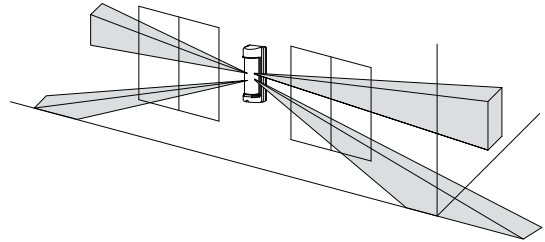

! IMPORTANT NOTES

Detection range/sensitivity may change depending on the following factors:

- Small difference of temperature between object and surroundings.
- Movement direction of the object.
- Mounting height.
- Mounting orientation.
- Slope in detection area.

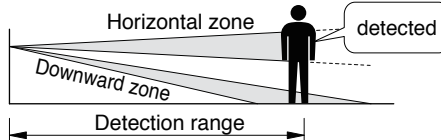
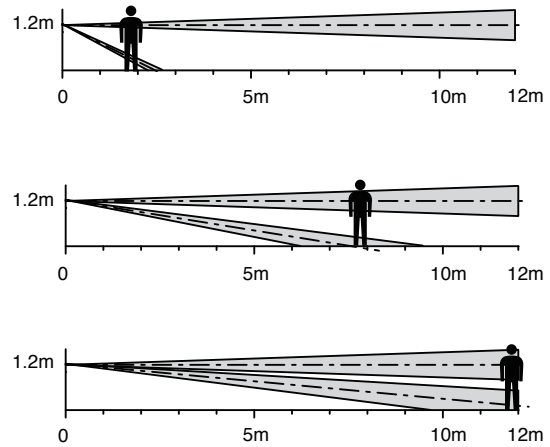
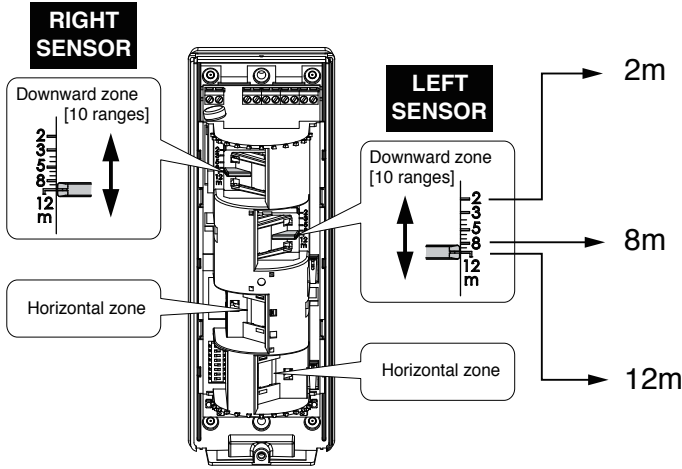

Alarm signal is issued only when both horizontal and downward zones detect objects.

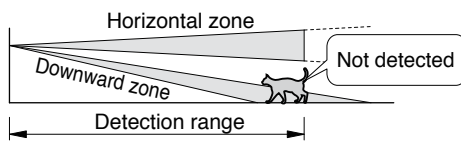

Small animals which are not likely to reach the height of horizontal zone will not be detected.

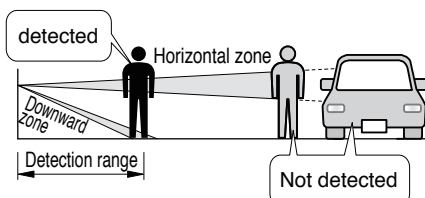

It does not detect vehicles moving in the area outside the range of the downward zone.

5-2 PIR Area masking

- (1) Pull out the area masking sheet from cover.
- (2) Bend or cut off the sheet to adjust it to the masking area.
- (3) Clip the mask to the protruding hooks around the optical unit.
 - In case of wall detection, set the pulse count to 1.
 - Carry out a walk test and check the detection area.

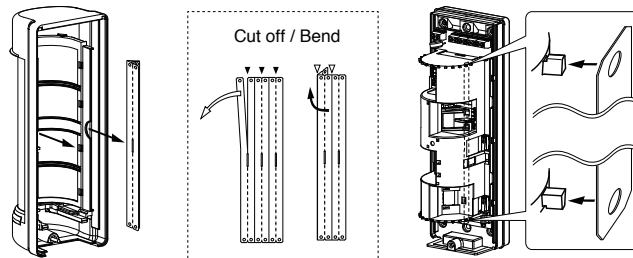

Protection 90 degrees

Wall / window protection

Partial masking

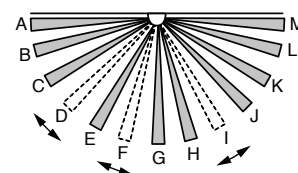
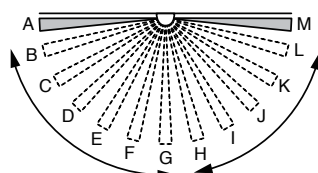
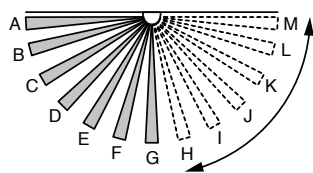
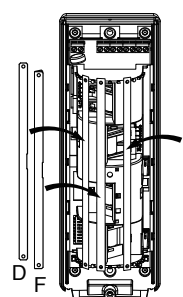
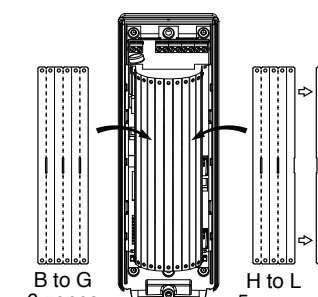
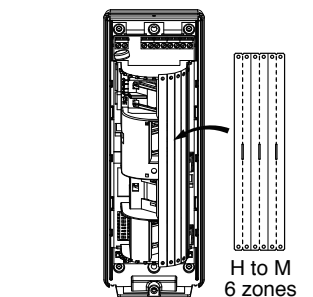

5-3 Switch setting

MODE SETTING

1,2	PIR SENSITIVITY	<input type="radio"/> 60	<input type="radio"/> 80
	RIGHT SIDE	<input type="radio"/> 100	<input type="radio"/> 120
3,4	PIR SENSITIVITY	<input type="radio"/> 60	<input type="radio"/> 80
	LEFT SIDE	<input type="radio"/> 100	<input type="radio"/> 120
5	PULSE COUNT	<input type="radio"/> 1	<input type="radio"/> 3
6	ANTI-MASKING	<input type="radio"/> OFF	<input type="radio"/> ON
7	ALARM OUTPUT	<input type="radio"/> N.C.	<input type="radio"/> N.O.
8	ALARM FUNCTION	<input type="radio"/> OFF	<input type="radio"/> ON

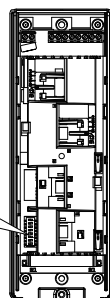
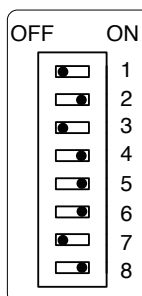

[Factory set]

1, 2	PIR SENSITIVITY [RIGHT SIDE]	OFF <input type="radio"/> 1	60%	6	ANTI-MASKING	ON <input checked="" type="radio"/> 6	ON [Factory set]	
		OFF <input type="radio"/> 2				OFF <input type="radio"/> 6	OFF	
		OFF <input type="radio"/> 1	80%		7	ALARM OUTPUT	OFF <input checked="" type="radio"/> 7	N.C. [Factory set]
		OFF <input type="radio"/> 2					ON <input type="radio"/> 7	N.O.
OFF <input type="radio"/> 1	100% [Factory set]	8	ALARM FUNCTION	ON <input type="radio"/> 8 [Factory set]		ON		
ON <input type="radio"/> 1				ALARM(1)		Right + Left		
ON <input type="radio"/> 2	120%			OFF <input type="radio"/> 8	ALARM(2) N.O. only	External output to Camera or ancillary device		
ON <input type="radio"/> 2				OFF <input type="radio"/> 8	OFF			
3, 4	PIR SENSITIVITY [LEFT SIDE]	OFF <input type="radio"/> 3	60%	8	ALARM FUNCTION	OFF <input type="radio"/> 8	OFF	
		OFF <input type="radio"/> 4				80%	ALARM(1)	Right
		OFF <input type="radio"/> 3	100% [Factory set]				ALARM(2)	Left
		OFF <input type="radio"/> 4				120%	OFF <input type="radio"/> 8	OFF
ON <input type="radio"/> 3	3 [Factory set]	ON <input type="radio"/> 8	ON					
ON <input type="radio"/> 4		1	OFF <input type="radio"/> 8	OFF				

6 CHECKING

6-1 Operation check

- (1) Replace the cover to automatically start the operation check and walk test function (for 5 min) after 1 min of LED blinking.
- (2) Check that the LED lights on both detection side (left and right) within the set detection area.
- (3) Readjust the detection area if necessary.
- (4) Anti-masking performs learning function for 3 min after cover is replaced. For this to be successful, do not have any object within 10cm of the lens during this period.
- (5) Check also operation of connected devices, when applicable.

6-2 LED indication

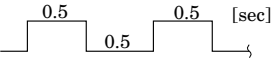
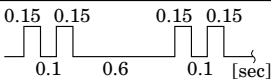
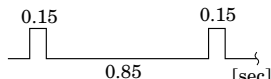
Status	LED operation	Recovery
Warm-up	Blinking (approx. 1min)  [sec]	
Alarm detection	Walk test Lights (approx. 2sec) -Mode setting "8" ON : Left and Right -Mode setting "8" OFF : Left or Right (LED's corresponding to left/right zones)	
	Operation	No
Masking detection	Blinking rapidly  [sec]	After resolving the cause, either open/close the cover, or allow the unit 15 seconds reset time without motion and then activate twice
Self diagnosis error*	Lights continuously	Return to the normal status by power supply reset
Low supply voltage**	Blinking slowly  [sec]	Return to the normal voltage by power supply reset

*Detection and notification of the problems caused by broken wiring inside the sensor, malfunction, etc.

**Monitoring and notification in case input power supply voltage to the sensor is reduced.

7 TROUBLESHOOTING

Solve possible problems according to the following table. If normal operations cannot be restored by this means, contact either the dealer from whom you bought the unit or TAKEX.

Trouble	Check	Corrective Action
The sensor does not detect anything	<ol style="list-style-type: none"> (1) No power supply (including broken wiring), or the power supply voltage is low. (2) The detection area is blocked by an object (which may include glass). (3) Unsuitable detection area settings (including detection distance). (4) Approximately 1 minute has not passed since turning the power ON. 	<ol style="list-style-type: none"> (1) Check the power wiring, and power supply voltage. → [4. WIRING] (2) Remove obstacles. (3) Readjust detection area. → [5. SETTING] (4) Wait approximately 1 minute.
The sensor sometimes does not detect anything	<ol style="list-style-type: none"> (1) Unsuitable detection area settings (including detection distance). (2) The detection lens is covered with dust or water droplets. (3) Unsuitable detection or pulse count settings. 	<ol style="list-style-type: none"> (1) Readjust detection area. → [5. SETTING] (2) Clean the lens with a damp soft cloth, and wipe off water droplets. (3) Readjust the settings. → [5. SETTING]
The sensor generates an alarm, although there are no people within detection area	<ol style="list-style-type: none"> (1) Unstable power supply voltage. (2) Something is moving within the detection area, or there are sudden changes in temperature. (3) A source of electrical noise (broadcasting station, amateur radio station, etc.) is nearby. (4) Direct or reflected light such as sunlight or headlights sometimes shines onto the sensor itself or into the detection area. (5) The sensor is mounted on an angle (the horizontal zone is tilted). (6) Cars or motorcycles are sometimes detected at the edge of the detection area. 	<ol style="list-style-type: none"> (1) Ensure appropriate power supply voltage. (2) Identify the problem object, and remove it. (3) Change the mounting location or remove the noise source. → [7. PRECAUTIONS] (4) Change the mounting location, or location of the reflective item. Readjust detection area. Use the area masking sheet to hide zones for which detection is not required. → [5. SETTING] (5) Change the mounting location. → [5. SETTING] (6) Reduce the set distance. Readjust detection area. → [5. SETTING]
The operation LED is on, but connected devices are not operating.	<ol style="list-style-type: none"> (1) Wiring failure, broken wire, or short-circuit. (2) Check that connected devices are operating correctly. 	<ol style="list-style-type: none"> (1) Connect wiring correctly. (2) Investigate with reference to the instruction manuals of the connected devices.

MAINTENANCE

1. Clean the device with a soft, damp cloth and wipe off water drops. Use water with weak neutral detergent to clean stubborn dirt. Do not use substances such as thinner or benzene.
2. Perform operation check on a regular basis.

8 SPECIFICATIONS

Model	MX-12FAM	
Detection system	Passive infrared	
Detection area	Horizontal detection Angle : 180°, Detection distance : 12m(40') Horizontal zone : 14 zones Downward zone : 14 zones	
Area adjustment	Detection distance : 2 to 12m(10' to 40') [10 ranges] (by adjusting vertical angle of downward curtain) Possible left and right individual adjustment	
Supply voltage	9 to 28V DC (non-polarity)	
Current consumption	30mA Max.	
Alarm output (1)	ALARM RIGHT+LEFT	Dry contact relay output N.O./N.C. selectable • Contact capacity : 30V (AC/DC) 0.2A Max. (Resistive load) • Contact operation : Detection time (+2sec.)
	ALARM RIGHT	
Alarm output (2)	ALARM LEFT	Dry contact relay output N.O./N.C. selectable • Contact capacity : 30V (AC/DC) 0.2A Max. (Resistive load) • Contact operation : Detection time (+2sec.)
	EXTERNAL OUTPUT	
Trouble output	Dry contact relay output N.C. • Contact capacity : 30V (AC/DC) 0.2A Max.(Resistive load) (Masking detection / Low supply voltage / Self diagnosis error)	
Tamper output	Dry contact relay output N.C. • Contact capacity : 30V (AC/DC) 0.1A Max.(Resistive load) (Cover tamper / Back tamper (when enabled))	
Operation LED	Red LED • Warm-up (Blinking) • Alarm detection (Lights approx.2sec only for Walk test) • Low supply voltage (Blinking slowly) • Masking detection (Blinking rapidly) • Self diagnosis error (Lights continuously)	
Pulse count	1 / 3 times (selectable with DIP switch)	
Sensitivity adjustment	60% / 80% / 100% / 120% (selectable with DIP switch,Possible left and right set individually)	
Functions	Anti-masking, Back tamper, Trouble alarm, Low voltage monitoring	
Connection	Terminals	
Ambient temperature	-25°C to + 60°C (-13°F to + 140°F)	
Mounting position	Indoor / Outdoor	
Ingress protection	IP55 (Wall mount)	
Weight	350g (12.4oz)	
Appearance	Body : resin (white) / Lens : resin (white)	
Optional	Pole attachment : BP-32	

※ Specifications and design are subject to change without prior notice.

9 EXTERNAL DIMENTIONS

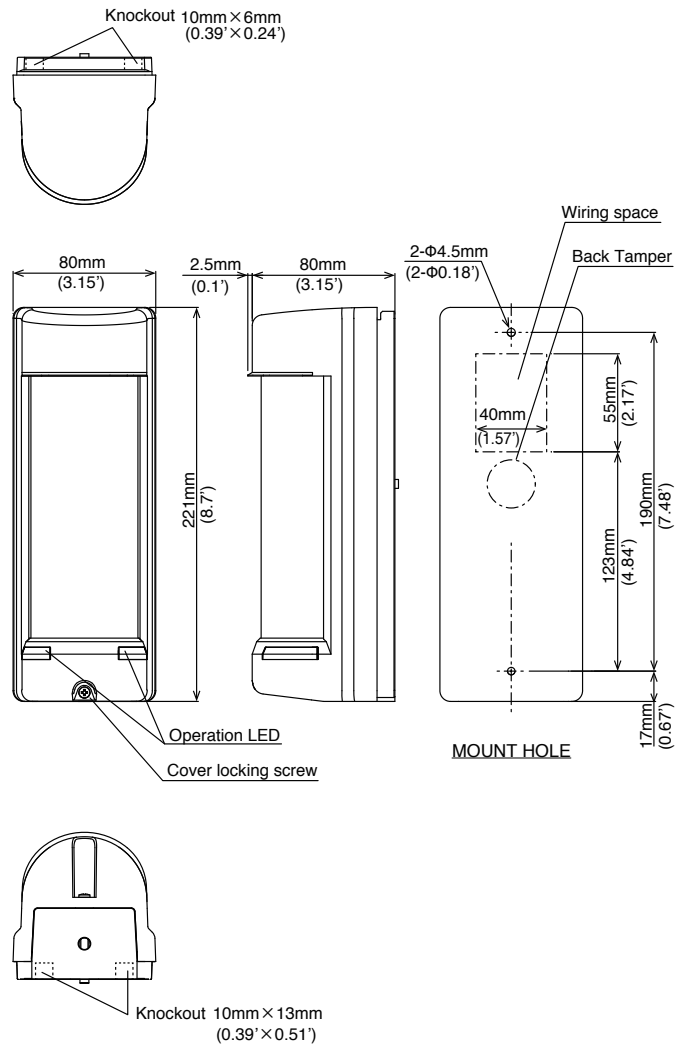

Limited Warranty :

TAKEX products are warranted to be free from defects in material and workmanship for 12 months from original date of shipment. Our warranty does not cover damage or failure caused by Acts of God (including inductive surge by lightning), abuse, misuse, abnormal usage, faulty installation, improper maintenance or any repairs other than those provided by TAKEX. All implied warranties with respect to TAKEX, including implied warranties for merchantability and implied warranties for fitness, are limited in duration to 12 months from original date of shipment. During the Warranty Period, TAKEX will repair or replace, at its sole option, free of charge, any defective parts returned prepaid. Please provide the model number of the products, original date of shipment and nature of difficulty being experienced. There will be charges rendered for product repairs made after our Warranty period has expired.

TAKEX TAKENAKA ENGINEERING CO., LTD.

In Japan

Takenaka Engineering Co., Ltd.
83-1, Gojo-Dori, Sotokan Nishi-iru, Higashino,
Yamashina-ku, Kyoto 607-8156, Japan
Tel : 81-75-501-6651
Fax : 81-75-593-3816
<https://www.takex-eng.co.jp/>

In the U.S.

Takex America Inc.
151, San Zeno WAY
Sunnyvale, CA 94086, USA
Tel : 408-747-0100
Fax : 408-734-1100
<https://www.takex.com>

In Australia

Takex America Inc.
4/15 Howleys Road, Notting Hill,
VIC, 3168
Tel : +61 (03) 9544-2477
Fax : +61 (03) 9543-2342
<https://www.takex.com>

In the U.K.

Takex Europe Ltd.
Aviary Court, Wade Road,
Basingstoke, Hampshire. RG24 8PE, U.K.
Tel : (+44) 01256-475555
Fax : (+44) 01256-466268
<https://www.takex.com>