

NETWORK KEYBOARD

User Manual

Please read this instruction carefully before using the product and keep it for further reference

Thank you for purchasing our product. There may be several technically incorrect places or printing errors in this manual. The updates will be added into the new version of this manual. We will readily improve or update the products or procedures described in the manual. The content is subject to change without notice.

Note

- LCD display can be easily damaged. Please do not press or exposure in sunshine for a long time.
- The joystick can be easily damaged. If it needs to be repaired, please wrap and ship it by using original or safety packaging.
- This keyboard should be used in certain range of temperature and humidity, referring the specifications.
- Please connect the keyboard correctly as this manual requires.

Items	quantity	Note
Network keyboard	1	/
DC12V power adapter	1	Input : AC100-240V
Power cable	1	/
CD	1	Included user manual

Contents

1	Introduction	1
1.1	Introduction.....	1
1.2	Rear Panel Instructions	1
1.3	Front Panel Instructions	1
1.4	Key press Rules.....	3
1.5	Joystick Control	3
2	Setup	5
2.1	Startup the Keyboard.....	5
2.2	System Setup.....	5
2.2.1	Password Setup	5
2.2.2	Keypad ID Setup	6
2.2.3	Network Setup.....	6
2.2.4	Default Setup.....	7
2.2.5	Question Setup	7
2.2.6	Playback Set.....	7
2.3	PTZ Setup	7
2.4	Language Setup.....	7
2.5	Test.....	8
3	PTZ Mode.....	9
3.1	Mode Setup	9
3.2	PTZ IP Setup	9
3.3	PTZ Operation	9
3.4	PTZ Shift.....	9
4	Decoding	11
4.1	Call Layout.....	11
4.2	Screen Display Mode	12
4.3	Camera->Monitor	12
4.4	Camera Group-> Window.....	13
4.5	Set and Call Macro.....	13
4.6	PTZ Control	14
4.6.1	Move or Stop.....	14
4.6.2	Set or Call Preset.....	14
4.6.3	Call or Stop Cruise/Track.....	15
4.6.4	Focus +/-.....	16
4.6.5	Zoom +/-.....	16
4.6.6	Iris +/-.....	16
4.6.7	Start or Stop Auto Scan	16
4.6.8	Enable/Disable Light.....	17
4.6.9	Enable/Disable Wiper.....	17

4.7 Record Playback	17
4.7.1 Start Playback.....	17
4.7.2 Pause Playback.....	17
4.7.3 Play the Previous 30s	18
4.7.4 Play the Next 30s or Frame	18
4.7.5 Stop Playback.....	18
5 Others	19
5.1 View Information	19
5.2 Lock	19
6 Web	20
6.1 Web Access	20
6.2 Upgrade.....	21
7 Specifications.....	22
Appendix.....	23

1 Introduction

1.1 Introduction

This network keyboard is fully compatible with the VMS of Provision-ISR, which can control cameras, video wall, monitor, etc. The menu contain an easy to use interface that includes all of the setting methods.

1.2 Rear Panel Instructions





Name	Description
PW	When the network keyboard is working, the power indicator turns red.
LINK	The network status indicator
RS232	Internal testing port
RJ45	RJ45 network port
RS485	Connect speed dome or the RS485 port of the DVR; TA connects to RS485+; TB connects to RS485- (unavailable)
DC-12V	DC12V power input
WIFI	Unavailable
	Grounding

1.3 Front Panel Instructions

Introduction



Name	Functions
SETUP	Local setup, such as keyboard ID, network setup, working mode ETC'
INFO	Local information, such as ID, model, network parameters.
SHIFT	Auxiliary key for main interface shift or PTZ shift or security questions shift.
LOCK	Lock keyboard; press this key to lock the keyboard.
MON	Choose a TV wall.
WIN	Choose a window to play a video
CAM	Select the camera to play on the chosen window
MULT	Split the screen to 1,4,9,16,25,36
MON-G	Select the output group (monitor group) (unavailable)
CAM-G	Select the input group (camera group)
LAYOUT	Call a layout (TV-Wall plan)
AUDIO	Enable/disable audio of the selected window. (unavailable)
▶	Play
⏸	Pause
■	Stop
●	Enable / disable manual record. (unavailable)
⏮	Jump to the previous 30 seconds from the current playing time
⏭	Jump to the next 30 seconds from the current playing time

	when the record is paused, pressing  OR  will skip one frame forward/back
MACRO	Create a sequence of actions, and call them using MACRO.
ALARM	Set the first image of the current output as an alarm large image. (unavailable)
0-9	Input the number/ alphabetical /symbol.
ESC	Cancel the operation; return to the previous menu.
ENTER	Enter menu or confirm to save the current settings.
PRESET	Set and call a preset.
CRUISE	Call or stop a cruise.
TRACK	Call or stop a track.
AUTO	Enable or disable an auto scan.
FOCUS+	Click to focus in.
FOCUS-	Click it to focus out.
ZOOM+	Zoom in
ZOOM-	Zoom out
IRIS+	Iris increases
IRIS-	Iris decreases
WIPER	Enable or disable wiper.
LIGHT	Enable or disable light.

1.4 Rules of Key Press

Double press--- the interval time between two presses less than 2 seconds. It mainly uses to switch the alphabet.

For example, press 2 twice to input A; press 2 three times to input B. Please see appendix for the detailed rules of key press.

When selecting or switching the operating object, it usually starts with the number key and ends with the corresponding functional key. Take the following as examples.











1+MON (press 1 and then press MON)—— select No.1 TV wall

123+CAM (press 1, 2, 3 and then press CAM)—— select No.123 Camera

10+PRESET (press 1, 0 and then press PRESET)—— call preset 10

1.5 Joystick Control

Introduction

Figure	Operation	Function
	Up	In PTZ control mode: control the speed dome to move up.
	Down	In PTZ control mode: control the speed dome to move down.
	Left	In PTZ control mode: control the speed dome to move left.
	Right	In PTZ control mode: control the speed dome to move right.
	Upper left	In PTZ control mode: control the speed dome to move towards upper left.
	Upper right	In PTZ control mode: control the speed dome to move towards upper right.
	Lower left	In PTZ control mode: control the speed dome to move towards lower left.
	Lower right	In PTZ control mode: control the speed dome to move towards lower right.
	Rotate left	Zoom in
	Rotate right	Zoom out

2 Setup

2.1 Startup the Keyboard

Connect the network cable to the keyboard and then connect the power. After the device starts, please enter the default password (8888) and then press “Enter” key to go to main interface (see left image). Press “Setup” key to go to the system setup menu (see right two images).

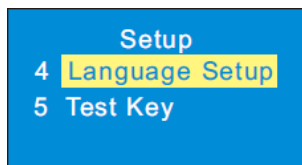
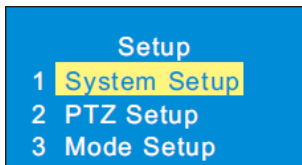
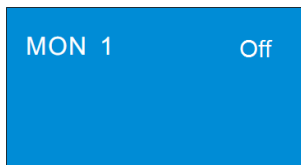

2.2 System Setup

Use the joystick to maneuver between the menus, press ENTER to choose.

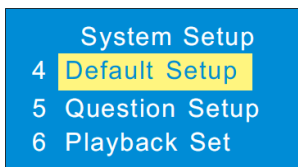
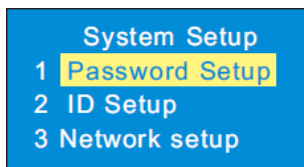

2.2.1 Password Setup

Select the password setup menu and press “Enter” key to go to the password setup.

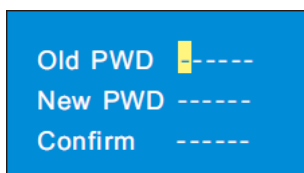

Enter the old password by moving the joystick right one by one (the default password is 8888). Select the new password by moving the joystick down and then enter the new password as the above mentioned method. Finally confirm the new password and press “Enter” key to save the settings. If you want to change the inputted number, please move the joystick to the current position to change the current number. If you want to cancel the inputted number, you can press “0” for two times. Press “Enter” key to save the new password. Press “Cancel” key to return to the previous menu.

Setup

2.2.2 Keypad ID Setup

Select the keypad ID setup menu and press “Enter” key to go to the keypad ID setup.

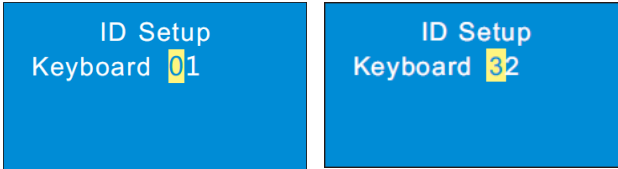

The ID number ranges from 1 to 32.

To set keypad ID, press the digital number and “Enter” key (eg. press 32 and then press “Enter” to set the keypad ID at 32).

2.2.3 Network Setup

Network setup includes local IP setup, PLAT(platform=Ossia VMS) IP setup and PTZ IP setup. The local IP address and any other device you choose (platform, PTZ ETC’) should be on the **same** network segment.

➤ Local IP Setup

Select “Local IP Setup” and press “Enter” to go to local IP setup. You can set the local IP address, subnet mask, default gateway, DNS server, alternate DNS and HTTP port.

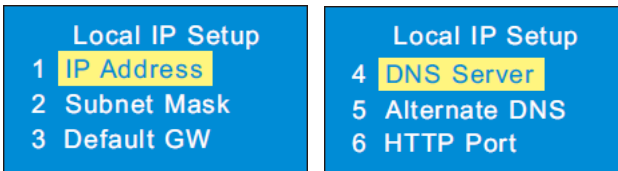

- ❖ IP address: Select IP address and press “Enter” to set the IP address. The default IP address is 192.168.1.201.

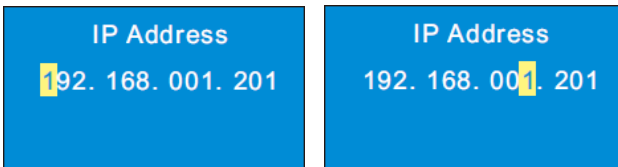

Tips: Move the joystick right to set the IP address. Press “Enter” to save the settings and return to the previous menu.

- ❖ Subnet mask: Select subnet mask and press “Enter” to set subnet mask. The default subnet mask is 255.255.255.0.
- ❖ Default GW: The default gateway is 192.168.1.1. Please input it according to the actual network.

- ❖ DNS server: The default DNS server is 8.8.8.8. Please input it according to the actual network.
- ❖ Alternate server: The default alternate server is 4.4.4.4. Please input it according to the actual network.
- ❖ HTTP port: The default http port is 4000. Please input it according to the actual network.

➤ PLAT IP Setup

Select “PLAT IP setup” and press “Enter” to set the PLAT IP address.

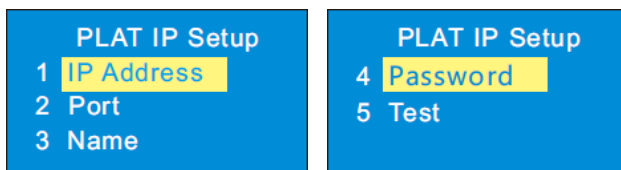

- ❖ IP address: Enter the IP address of the VMS management server.
- ❖ Port: The default port is 6003. The port must be the same with that of the Management server.
- ❖ Name and password: The name and password must be the same with that of the Management server.
- ❖ Test: To test if the keyboard connecting to the management server.

➤ PTZ IP Setup

Please see [3.2 PTZ IP Setup](#) for details.

2.2.4 Default Setup

Select it and press “Enter” to restore the system settings to the default factory settings.

2.2.5 Question Setup

Select it and press “Enter” to set the security question which can reset your password.

2.2.6 Playback Set

Only some models support this function.

Select it and press “Enter” to set instant playback time when using the network keyboard to control video output of the decoder.

2.3 PTZ Setup

Select it and press “Enter” to go to the settings of PTZ to set the speed of the PTZ.

2.4 Language Setup

Select it and press “Enter” to switch the language between English, Chinese, Polish, Hungarian, Italian , Spanish.

Setup

2.5 Test

Select it and press “Enter” , Now you can press any key you want, making sure it’s responsive.

3 PTZ Mode

3.1 Mode Setup

Choose between Platform mode, and PTZ mode. The settings for platform mode were already done previously in system setup.

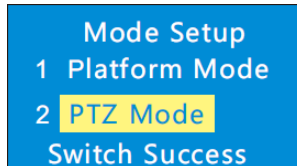

Tip: In PTZ mode, you only need to select the PTZ to operate, no need to choose the output and the window. The other actions are similar to the platform mode.

3.2 PTZ IP Setup

Go to Network Setup to select “PTZ IP Setup” and press “Enter” to go to select the PTZ. Then set the IP address, port, name, password of the selected PTZ.

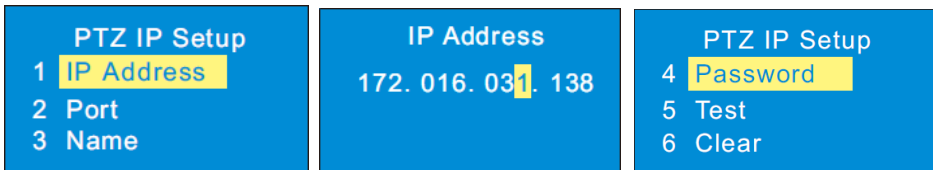

- ❖ IP address: Enter the IP address of the PTZ. This IP address can be either a local IP address, or a remote IP address. If it's remote, make sure to forward the HTTP port.
- ❖ Port: The default port is 80 (the http port of the PTZ).
- ❖ Name and password: Put the username and password of the PTZ camera.
- ❖ Test: Test if the PTZ is online.
- ❖ Clear: Clear the information of the PTZ.

3.3 PTZ Operation

After setting up the IP address, port, name and password of the PTZ you can operate the PTZ by joystick or PTZ controller keys. Please see [4.8 PTZ Control](#) for more details.

3.4 PTZ Shift

Shift between 2 or more different PTZ cameras you added to the IP-KEY02

PTZ Mode

Add another PTZ and setup the IP address, port, name and password. Please see [3.2 PTZ IP Setup](#) for more details.

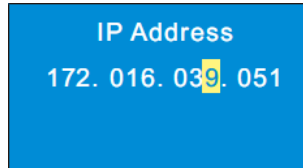
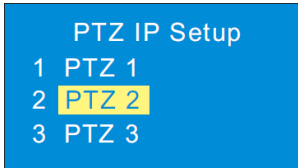

Press “SHIFT” to quick-switch between the PTZ you want to operate.

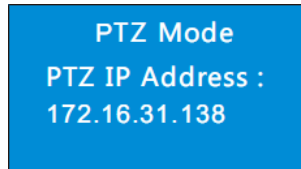
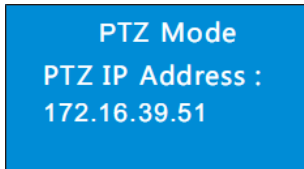

4 Decoding

Before using the network keyboard to control video output of the decoder, please make sure the authentication server, media transfer server, storage server, alarm server and TV wall server of the VMS all started and connected to the decoder.

Set up a TV-Wall

Go to TV Wall Management→TV Wall Setting interface to create a TV wall.

Then double click the TV wall name to view the initial layout of the TV wall. Drag the outputs of decoders to the corresponding windows and then save them.

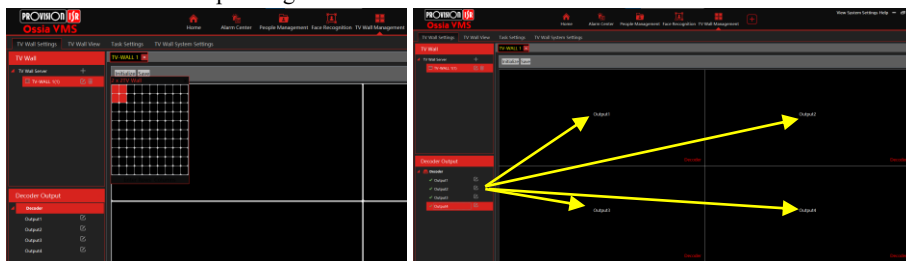

TIP: you can use multiple decoders and drag their corresponding HDMI outputs to their actual windows and form your desired TV-Wall.

* In order to view TV-Wall number and edit it, go to: TV-Wall Management→TV Wall Setting. And press .

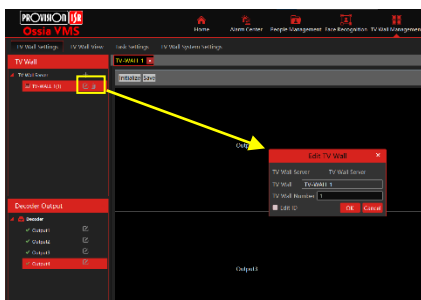

4.1 Call Layout

Layout IS Plan. So First, we need to set a plan: Go to the TV wall view interface and then select the plan tag to add a plan. Double click the plan name to show the plan. Then drag the monitoring points to the corresponding window respectively to start decoding videos. After that, click “Save” or “Save As” to save this plan.

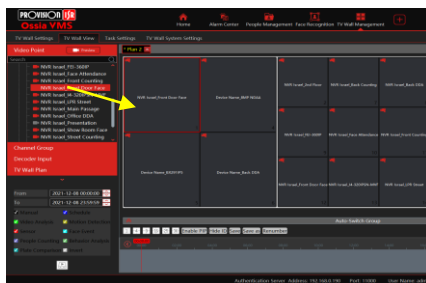

When controlling plans, the number of the plan can be viewed through clicking TV Wall Management→TV Wall View→TV Wall Plan. You can also edit this plan in this interface.

Edit TV-Wall plan: In the TV Wall Plan interface, click  beside the plan name to edit it. Set a number between 1 to 9999. You can then call the saved plan by entering number and pressing “LAYOUT” on the network keyboard.

After the plan was set in advance, now we call it through the network keyboard. The operation steps are as follows.

1. Select a TV wall. For example: enter “1” and then press “MON” key to select No. 1 TV wall.
2. Select a plan (layout). For example: enter “1” and then press “LAYOUT” key to select Layout 1.

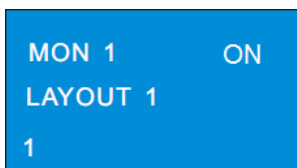

Decoding

4.2 Screen Display Mode

One monitor/HDMI output can support a 1/4/9/16/25/36 screen display mode.

Important: the first screen of each monitor/HDMI is numbered as a sequence of 1..2..3..4..ETC'

For example:

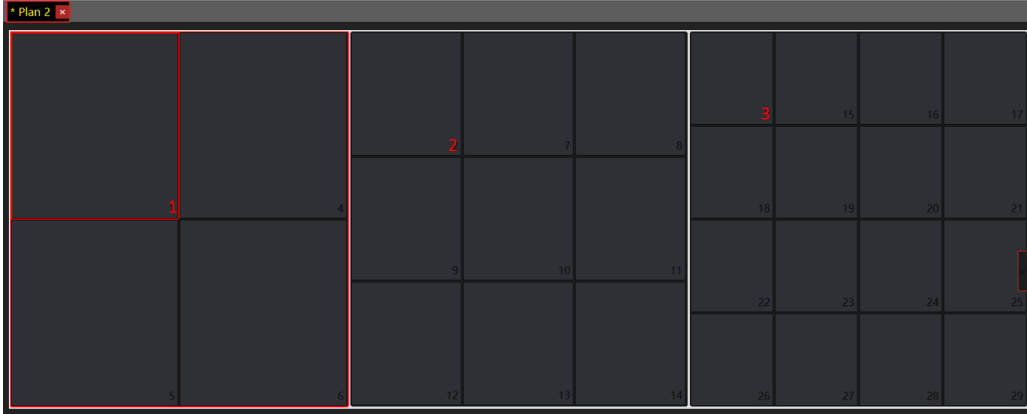

That way you can easily choose the screen you are about to split. Even if you have 100 of them.

To set the screen display mode:

1. Select a TV wall by entering the TV-Wall number and then press “MON” key to choose this TV-wall. For example, enter “1” and then press “MON” to select No. 1 TV wall.
2. Select a window. For example, enter “3” and then press “WIN” to select No. 3 window.
3. Select the screen display mode: For example, enter “25” and then press “MULT” to select 25 screens display mode.

Then, No.3 window of TV wall 1 will be switched to 25-screen display mode.

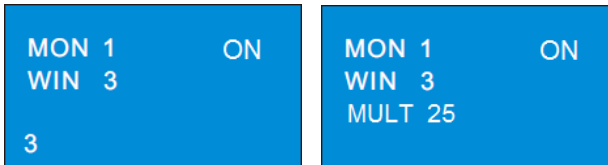

Note: * The number of possible windows ranges from 1 to 999. The maximum number of screen display mode for a single monitor is 36 screens. As a result, the maximum of 36 screens can be called when controlling TV wall.

4.3 How to send a camera to a selected window

Select the input signal (camera) to the designated TV wall and window.

1. Select a TV wall. For example, enter “1” and then press “MON” to select NO.1 TV wall.
2. Select a window. For example, enter “3” and then press “WIN” to select NO. 3 window.
3. Select a camera. For example, enter “2” and then press “CAM” to select NO. 2 camera.

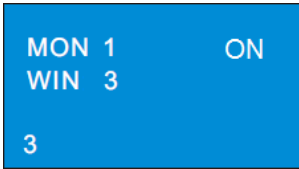

Each number corresponds to a video channel, to see what every number represent go to TV-Wall Management → TV-wall System Settings. You can also edit the numbers as you like:

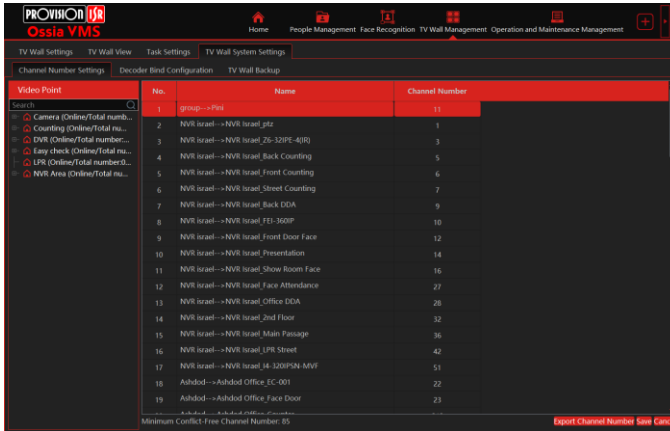

Note: The number of camera numbers is from 1 to 999999.

**When entering “0” and pressing “CAM”, it means to stop playing the current image.

4.4 How to send a camera Group to a selected window

Select a camera group and send to a chosen window.

The camera group will be played in sequence in this window. The setting steps are as follow:

1. Select a TV wall. For example, enter “1” and then press “MON” to select NO.1 TV wall.
2. Select a window. For example, enter “3” and then press “WIN” to select NO. 3 window.
3. Select a camera group. For example, enter “2” and then press “CAM-G” to select NO. 2 camera group.

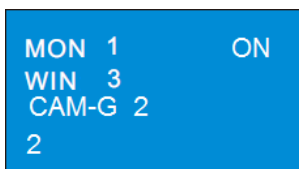
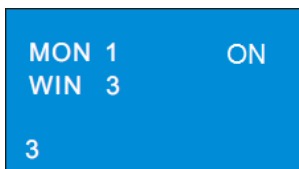

Camera group settings: Go to the Resource management -> channel group setting. This is the interface where you create a channel (camera) group and set its dwell time.

Note: The possible numbers are 1 to 999999. When entering “0” and then pressing “GAM-G”, it means stopping the auto-switch of the group in the specific window and only playing the image of the current camera. Enter “0” again to stop playing video.

When a channel group has played on a window, this group will be bound to this window. You should delete this group so that another group can be played on this specific window.

4.5 Set and Call Macro

Macro is used to provide a shortcut to execute a group of consecutive actions. A macro includes a maximum of 50 key orders. Macro instructions are saved in the keyboard.

Set-up Macro:

1. Enter the digital number and then press and hold “MACRO” key to set macro. For example, enter “2” and press “MACRO” key for more than 2 seconds to set NO.2 macro.
2. Enter a series of keys. For example, enter “1” and press “MON”, enter “2” and press “WIN”, enter “2” and press “CAM”.

Decoding

3. Press “Enter” to complete the macro setup.

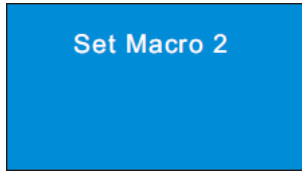

Call Macro:

Input digital number and then press “MACRO” to call NO. 2 macro instruction. Moving the joystick down displays all information of this macro. Press “ESC” key of the keyboard to return to the main menu of the keyboard.

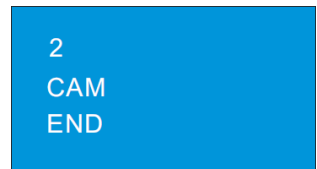
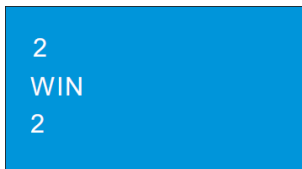
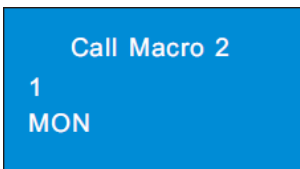

4.6 Conditions for controlling a PTZ

Only when the PTZ is input to the window and there is no sequence display in this window, you can control that PTZ. Also, the camera input on this window must be a PTZ camera (or a speed dome).

4.6.1 Controlling the PTZ

The setting steps are as follow.

1. Select a TV wall. For example, enter “1” and press “MON”.
2. Select a window. For example, enter “3” and press “WIN”.
3. Select a PTZ camera to be viewed. For example, enter “2” and press “CAM”
4. Control the speed dome/PTZ by moving the joystick. Leave the joystick for the PTZ to stop moving

Note: The camera input to the above example of NO. 2 camera must be a PTZ device (or speed dome). The possible number for presets is from 1 to 255. The possible number for cruises is from 1 to 8. The possible number for track is from 1 to 4. If the calling number is beyond the range, an invalid message will be displayed on the screen.

4.6.2 Set or Call Preset

To set preset

1. Select a TV wall. For example, enter “1” and then press “MON”.
2. Select a window. For example, enter “3” and then press “WIN”.
3. Set the position of the preset by moving joystick.
4. Press the digital number on the keyboard to select the number of preset. Then press “PRESET” for more than 2 seconds to set the preset. For example, enter “1” and then press “PRESET” for more

than 2 seconds to set the NO.1 preset.



To call preset

1. Select a TV wall. For example, enter “1” and press “MON”.
2. Select a window. For example, enter “3” and press “WIN”.
3. Select a preset. For example, enter “1” and press “Preset”.

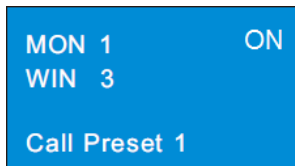

4.6.3 Call or Stop Cruise/Track

To call cruise/track

1. Select a TV wall. For example, enter “1” and press “MON”.
2. Select a window. For example, enter “3” and press “WIN”.
3. Select a cruise/track. For example, enter “1” and press “CRUISE/TRACK”.

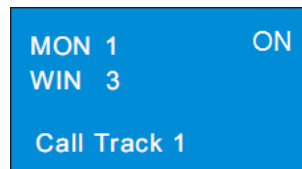
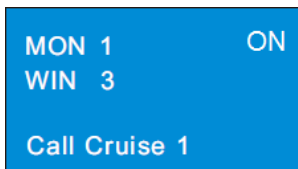

To stop cruise/track

1. Select a TV wall. For example, enter “1” and press “MON”.
2. Select a window. For example, enter “3” and press “WIN”.
3. Select a cruise/track. For example, enter “0” and press “CRUISE/TRACK”.

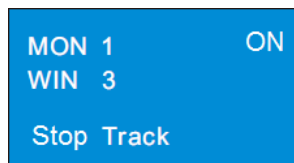
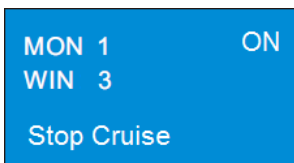

Decoding

4.6.4 Focus +/-

To set focus +/-

1. Select a TV wall. For example, enter “1” and press “MON”.
2. Select a window. For example, enter “3” and press “WIN”.
3. Press “FOCUS+” or “FOCUS-”.

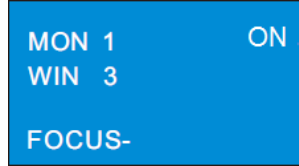
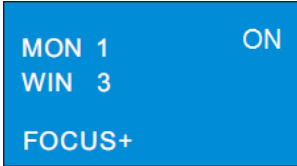

4.6.5 Zoom +/-

To set zoom +/-

1. Select a TV wall. For example, enter “1” and press “MON”.
2. Select a window. For example, enter “3” and press “WIN”.
3. Press “ZOOM+” or “ZOOM -”.

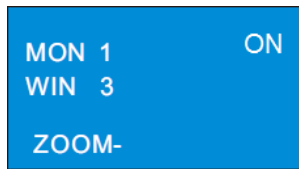
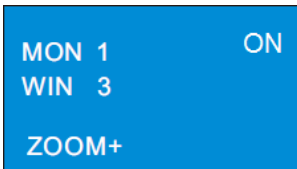

4.6.6 Iris +/-

To set iris +/-

1. Select a TV wall. For example, enter “1” and press “MON”.
2. Select a window. For example, enter “3” and press “WIN”.
3. Press “IRIS+” or “IRIS -”.

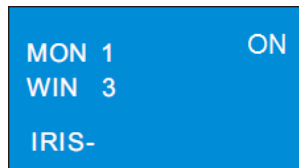
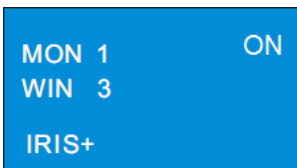

4.6.7 Start or Stop Auto Scan

To start or stop auto scan

1. Select a TV wall. For example, enter “1” and press “MON”.
2. Select a window. For example, enter “3” and press “WIN”.
3. Press “AUTO” to start auto scan; press “AUTO” again to stop auto scan.

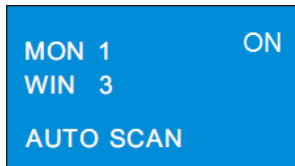

4.6.8 Enable/Disable Light

To enable or disable light

1. Select a TV wall. For example, enter “1” and press “MON”.
2. Select a window. For example, enter “3” and press “WIN”.
3. Press “LIGHT” to enable light; press “LIGHT” again to disable light.

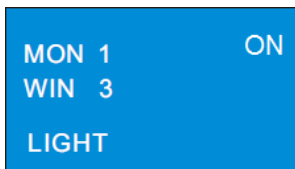

4.6.9 Enable/Disable Wiper

To enable or disable wiper

1. Select a TV wall. For example, enter “1” and press “MON”.
2. Select a window. For example, enter “3” and press “WIN”.
3. Press “WIPER” to enable light; press “WIPER” again to disable light.

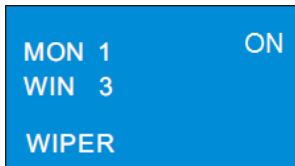

4.7 Record Playback

4.7.1 Start Playback

You can play back the record saved in the storage server of the Ossia VMS or NVR.

To play the record

1. Select a TV wall. For example, enter “1” and press “MON”.
2. Select a window. For example, enter “3” and press “WIN”.
3. Press ► key to play the record.



4.7.2 Pause Playback

When the record is in playing mode in the current window, press the pause key to pause playback.

4.7.3 Play the Previous 30s

Press  key to play the record of the previous 30 seconds.

4.7.4 Play the Next 30s or Frame

When the record is in playing mode, press  key to play the record of the next 30 seconds. When the record is in pause mode, press  key to play the next frame.

4.7.5 Stop Playback

When the record is in playing or pause mode, you may stop playback. The setting steps are as follow.

Press  key to stop playback.

5 Others

5.1 View Information

You may check the keyboard, model, SN, current mode, version, date, local IP, subnet mask and so on by pressing “INFO” key on the keyboard. Check the next page of the information by moving the joystick down.

Information Keyboard: 01	Information Model: xxx SN: xxx	Information Current Mode: Platform Mode	Information Vers: 1.0.1beta5 Date: 2016041904
-----------------------------	--------------------------------------	---	---

Information Local IP: 192.168.1.201	Information Subnet mask: 255.255.255.0	Information Default GW: 192.168.1.1	Information DNS server: 8.8.8.8
---	--	---	---------------------------------------

Information Alternate DNS: 4.4.4.4	Information HTTP Port: 4000	Information Platform IP: 192.168.1.100	Information Platform Port: 56789
--	-----------------------------------	--	--

5.2 Lock

You can lock the keyboard by pressing “LOCK” key. Enter the password (the default password is 8888) to unlock the keyboard.



When the keyboard is locked, all keys except digital keys on the keyboard are unavailable until you input the password to unlock the keyboard.

Tips: After inputting wrong password for more than 3 times you can reset password by answering the security questions set by you.

6 Web

6.1 Web Access

In order to view the keyboard from a network it should be connected to a LAN or internet. The network setup should be done accordingly.

- ① The keyboard shall be powered on and connected to the network. Please see [2.5 Local IP Setup](#) for details.
- ② Set the local IP address and HTTP port. The default local IP address is [192.168.001.201](#) and the default HTTP port is [4000](#). add the port number when typing the IP address in IE address blank as <http://192.168.001.201:4000> into IE browser.
- ③ Enter the password in the subsequent window (the default password is 8888).



- ❖ Please make sure the IP address of the web client is in the same local network as that of the keyboard. If the IP address of the keyboard is 192.168.001.201, the IP address of the IP client must be 192.168.001.XXX.
- ❖ The IP-Key02 can be searched by IP_Manager. Make sure the PC and keyboard are connected to the LAN and double click the IP_Manager icon to run this software. Then the keyboard can be searched; if the keyboard can't be searched, please check whether the PC and the keyboard are connected to the network or not. Double click the keyboard in IP-Tool and the system will pop up the web browser to connect to the keyboard.

You can check the system information. Click "logout" in the top-right corner and log out the IE client.

Network Keyboard Logout | System Information

Maintenance Upgrade	System Information	
	Keyboard Information	
	Keyboard SN:	Keyboard ID: 01
	Software Version: 1.1.0	Software Date: 201605231059
	Keyboard Model:	Language: English
	Local Network Information	
	IP Address: 192.168.16.201	
	Subnet Mask: 225.225.225.0	GateWay: 192.168.16.1
	Preferred DNS: 8.8.8.8	Alternate DNS: 4.4.4.4
	HTTP Port : 4000	

6.2 Upgrade

Get the software from your vendor when there is a new software version.

1. Click “Browse” button to select the save path of the upgrade file.
2. Click “Upgrade server firmware” to start upgrading the application program.
4. After successfully update the software, the device will restart automatically.

Network Keyboard Logout | System Information

Maintenance Upgrade	Upgrade
	Please select the upgrading file: <input type="text"/> <input type="button" value="Browse..."/> ,and click <input type="button" value="Upgrade"/>
	Note: The upgrading process will take a few minutes. The device will automatically reboot after the upgrade is complete.

Notice: You can't disconnect to PC or close the keyboard during upgrade.

7 Specifications

Local	Local Display	LCD
	Joystick	Four-dimensional
	Key	Four functional areas
Network	LAN	RJ45 10/100M×1
	Control Mode	Platform mode/ PTZ mode
Serial Port	RS485	RS485 ×1
	Baudrate	1200bps, 2400bps, 4800bps, 9600bps, 19200bps
Others	Power	DC12V
	Power Consumption	≤8W
	Working Temperature	-10°C~+60°C
	Working Humidity	10%~90%
	Dimension	420 (L) ×260(W)×170(H)mm
	Weight	2.8kg

Appendix

Digital number/ alphabet/symbol input rules are listed in the following table.

Key	The relationship between the frequency of key-press and input display								
	once	twice	three times	four times	five times	six times	seven times	eight times	nine times
1	1	,	.						
2	2	A	B	C	a	b	c		
3	3	D	E	F	d	e	f		
4	4	G	H	I	g	h	i		
5	5	J	K	L	j	k	l		
6	6	M	N	O	m	n	o		
7	7	P	Q	R	S	p	q	r	s
8	8	T	U	V	t	u	v		
9	9	W	X	Y	Z	w	x	y	z
0	0	blank							